

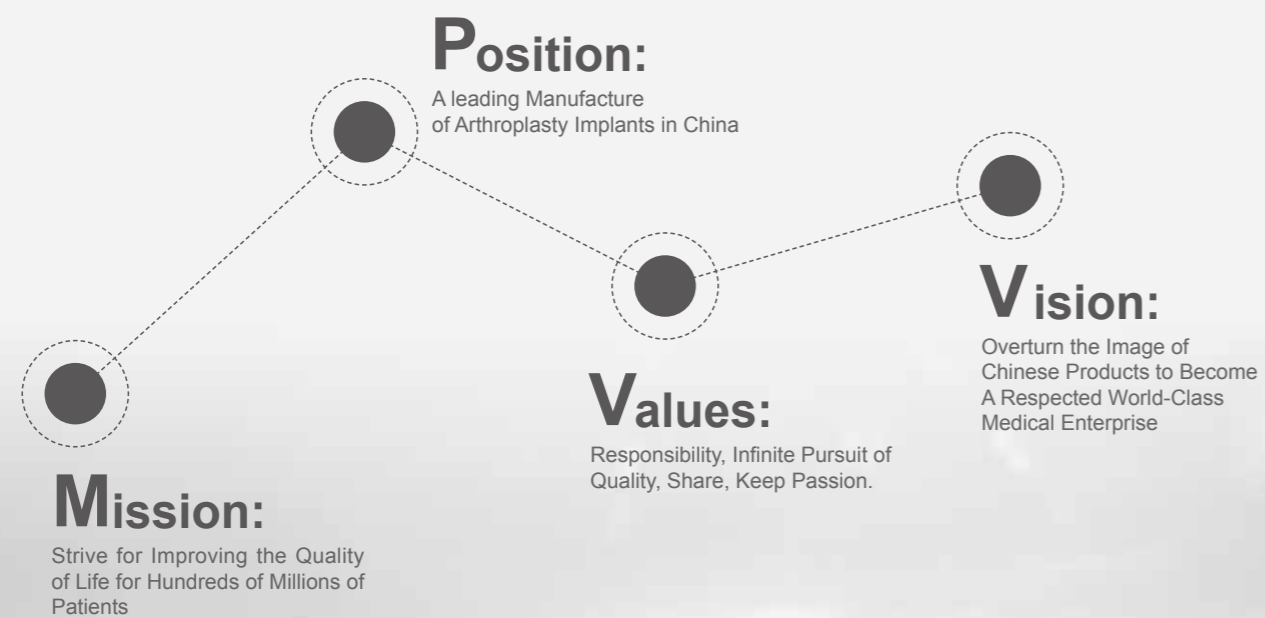

AK
MEDICAL



Product Catalogue



About US

- AK Medical, located in Beijing, is one of the largest company for hip, knee joints and 3D printed implants manufacturing. We concentrate our knowledge at the development of implants for hip, knee, 3D printing and surgical instruments.
- AK Medical specializes in the research, development, manufacture and sale of artificial joint prosthesis and their associated surgical instruments and applications. As an innovative company with a continuous dialog with leading surgeons, we develop, design and manufacture implants and instruments under our own control to reach the best result for the patients and surgeons. In less than 6 minutes, there is an AK brand artificial joint implanted, accumulated 300,000 joints implanted by the end of 2016. AK Medical has been a leading manufacturer of Arthroplasty implants inside of China, and the biggest 3D printing center in whole Asian countries.
- We have applied the 3D printing production systems into volume production of newly developed orthopedic implants since 2010. AK Medical has been an Arcam customer since 2010 and received the formal approval from the Chinese State Food and Drug Administration (CFDA) for EBM manufactured implants, this has been the very first government approval in the world for additive manufacturing implants.

WE
believe
that we can help
THE PATIENTS WALK NOW AND ALWAYS

Table of Contents

3D ACT SYSTEM

About 3D Printing Technology	2
3D ACT AK-AC-II-TTM-I Acetabular Cup	7
3D ACT AK-AC-II-TTM-V Acetabular Cup	8
3D ACT Titanium Trabecular Augment	9
TITAN Artificial Vertebral Body	12
METIS Artificial Cervical Cage	13

KNEE SYSTEM

A3 Primary Total Knee System	14
A3 GT Personalized Total Knee System	17
JPX Total Knee System	21
ACCK Revision Knee System	24
AK Hinge Knee System	27

HIP SYSTEM

AK Femoral Stem

AK-ML-TP Femoral Stem	30
AK-ML-TH Femoral Stem	32
AK-MP-TP Femoral Stem	34
AK-CL-TH Femoral Stem	35
AK-SL-Cone Femoral Stem	36
AK-SL Femoral Stem	37
AK-MR Femoral Stem	38
AK-ABM Femoral Stem	39
AK-SR Femoral Stem	40
CP II Cemented Femoral Stem	42
ACP and ACP Long Cemented Femoral Stem	43
AK-THS Tumor Femoral Stem	44

Acetabular System

AK-AC-I-TP Acetabular Cup with Liner	46
AK-AC-II-TP Acetabular Cup	47
AK-L-II-Liner	48
CP II & CP Acetabular Cup	49
AK-C-Liner Ceramic / AK-FH-C Femoral Head	50
AK-Bipolar / AK-FH-M Femoral Head	51
Acetabular Cup Screw	52
Acetabular Cage	53

ACCESSORIES

Centralizer / Restrictor/ Spacer Mold	54
Bone Cement Applicator	55
Bone Cement Application Kit	55
Tornado Disposable Surgical Lavage Unit	55



3D ACT Hip System

World's First Breakthrough 3D Printed Hip Joint System Approved by Clinical Trial

China's First Breakthrough 3D Printed Hip Joint System Approved by CFDA



**AK
MEDICAL**



Technical Flow Process

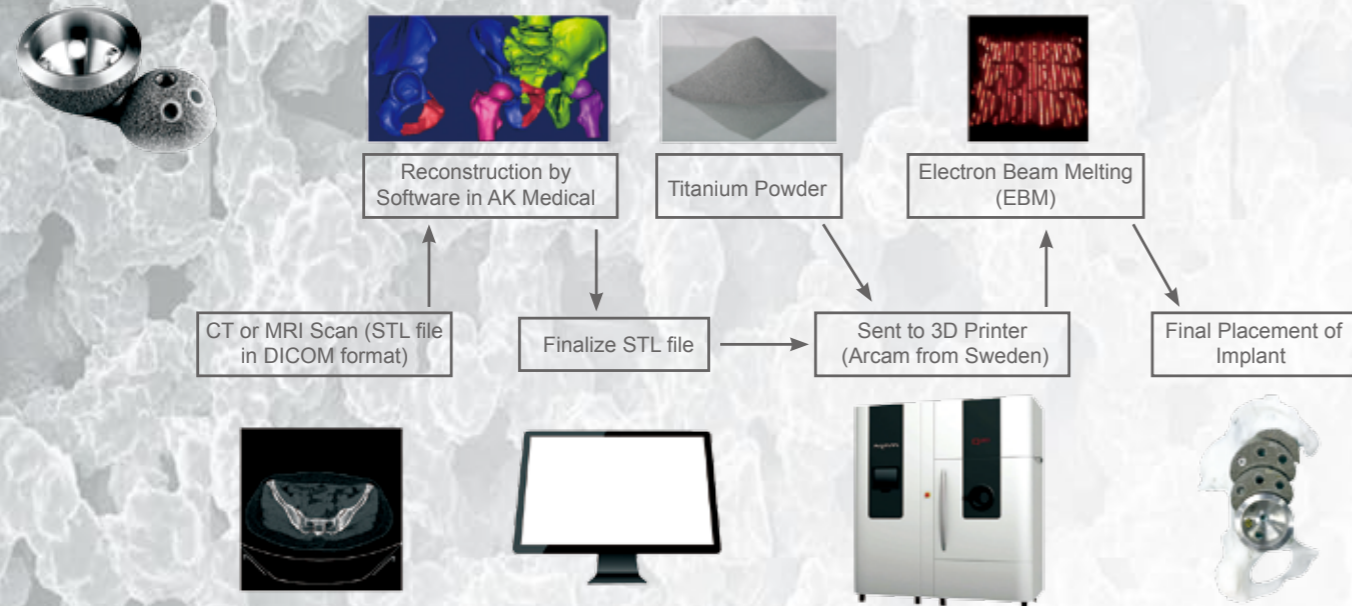

To Order a Customized Implant

Let's Scan

The first step in Customized Implants is sending your patient for a CT/MRI scan. The scan should be at least 0.6mm slice thickness in DICOM format (a STL file). You can copy the file and send it to us in a CD or just email it to us via the network disk (www.spaces.hightail.com or www.wetransfer.com)

Let's Plan

The second step in Customized Implants Surgery is to get a 3D conversion of your patients CT scan. A 3D conversion is a reconstruction of the patient's diseased region from the CT scan slices. It can also include segmentation of the anatomy into separate 3D layers. Using the very latest in Software technology, the implant size, length and position is planned; vital structures adjacent to the implant are noted and maneuvered.

Let's Implant

The third step in Customized Implants Surgery is to make the final placement of implant with a professional surgeon.

A3 Cutting Block

CT Data Requirement

Method I: Provide image data for hip joint, knee joint and ankle joint.



Method II: Provide CT data around knee and lower limb.



To Order a Cutting Block

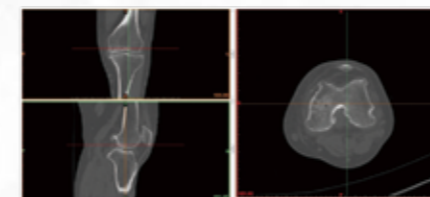

①CT or MRI Scan (STL file in DICOM format)

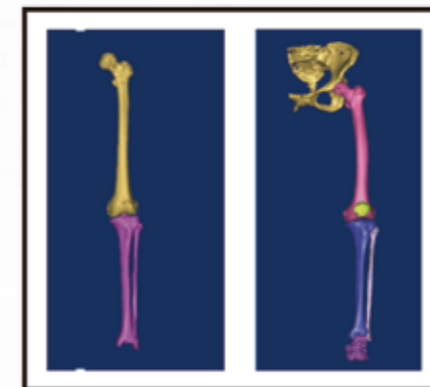

②Reconstruction by Software in AK Medical

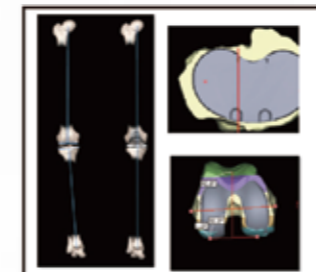

③Surgical planning based on client's inputs

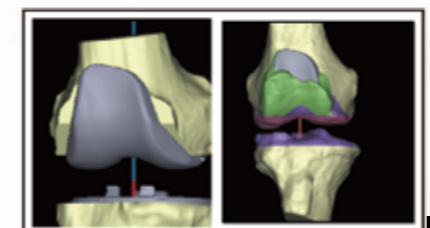

④Prosthesis simulated implantation

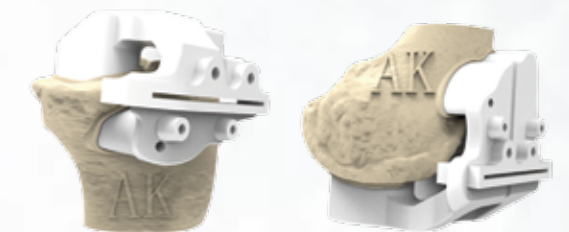

⑦Producing cutting block

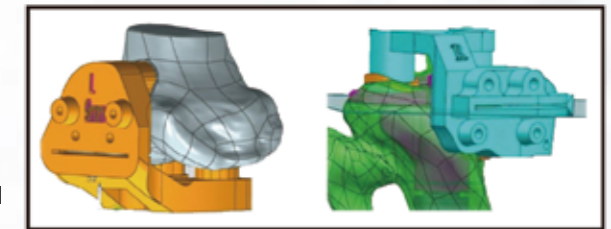

⑥Finalize STL file

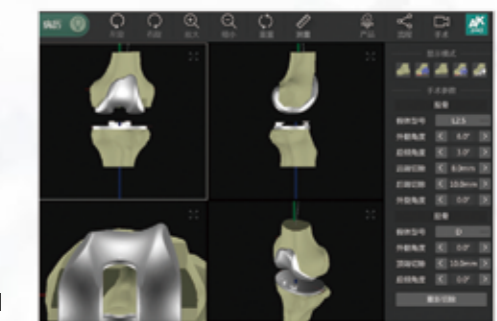

⑤Images sent to surgeon—Surgeon approves

3D Printing Process

- AK 3D printing Trabecular Titanium implants are built via the most advanced Electron Beam Melting (EBM) technology, using a high-energy focused beam to locally melt titanium powders layer upon layer

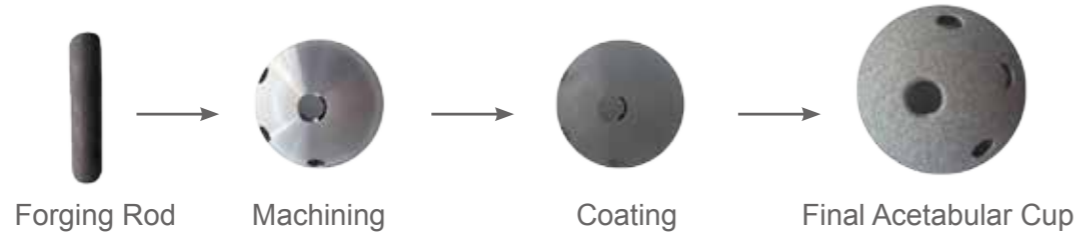

Process Comparison

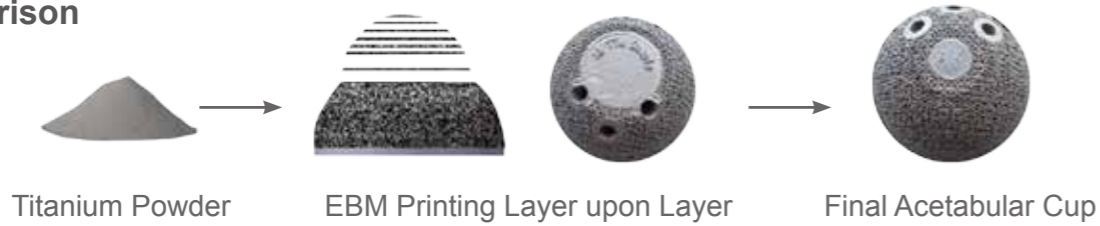

- The Trabecular Titanium structure is not a coating

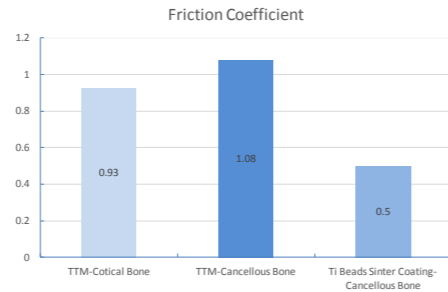
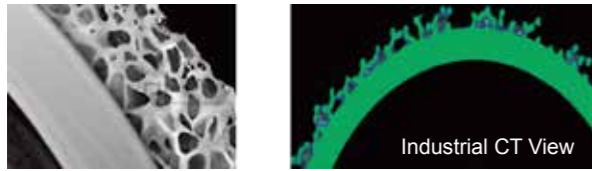

- Overcoming the coating concept, there is no interface between the bulk structure and the porous trabecular surface, no risk of detachment

- The Trabecular Titanium structure is not a coating, but the bone in-growth friendly interconnected 3D-geometric structure, it is created by Electron Beam Melted free from fabricated technology, the effectively long-term osseointegration and biocompatibility have been proved in many published studies

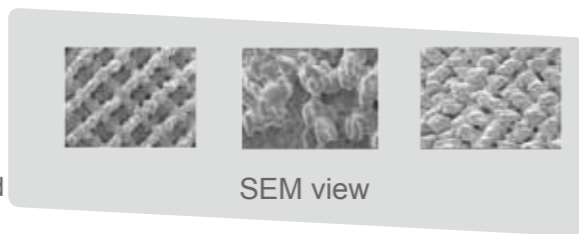

- With the 3D printing technology, it is possible to obtain to a perfectly controlled porosity

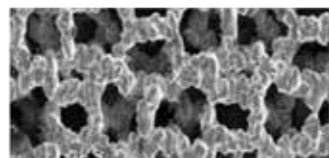

Reference	3D ACT System
Diameter	600µm~1000µm
Porosity	60%~90%

3D ACT System

AK-AC-II-TTM-I Acetabular Cup

- Trabecular Metal Technology offers a high coefficient of friction which helps reduce micromotion, enabling tissue growth. Its 3D construct provides a high level of porosity and potential for osteoconductivity allows for more rapid in-growth supporting a vascularized structure to maintain healthy bone. Implant durability leads to longevity and reduced risk for future surgeries;
- Liner ring serration design provides stable fixation between shell and liner and minimizes micromotion.



AK-AC-II-TTM-I Acetabular Cup

Size Ref. (O.D./I.D.)	Cat. No.	Description	Matched Liner size (O.D./I.D.)	Matched Liner size (O.D./I.D.)	Matched Liner size (O.D./I.D.)	Matched Femoral Head Dia.
38/32	2323-3832	Name: AK-AC-II-TTM-I Acetabular Cup Material: Titanium Alloy Customized Supplied Surface: Titanium Trabecular Metal, 3D-geometric Structure Matched Liner: AK-L-II Liner HXLPE Matched Stem: AK-ML-TP, AK-ML-TH, AK-MP-TP, AK-MR, AK-SL, AK-MF, AK-SR	32/22	-	-	22
40/32	2323-4032		32/22	-	-	22
42/34	2323-4234		34/22	-	-	22
44/36	2323-4436		36/22	36/28	-	22/28
46/38	2323-4638		38/28	-	-	28
48/40	2323-4840		40/28	-	-	28
50/42	2323-5042		42/28	42/32	-	28/32
52/44	2323-5244		44/28	44/32	-	28/32
54/46	2323-5446		46/28	46/32	46/36	28/32/36
56/48	2323-5648		48/28	48/32	48/36	28/32/36
58/50	2323-5850		50/28	50/32	50/36	28/32/36
60/52	2323-6052		52/28	52/32	52/36	28/32/36
62/54	2323-6254		54/28	54/32	54/36	28/32/36
64/54	2323-6454		54/28	54/32	54/36	28/32/36
66/58	2323-6658		58/28	58/32	58/36	28/32/36
68/58	2323-6858		58/28	58/32	58/36	28/32/36
70/60	2323-7060	60/28	60/32	60/36	28/32/36	

3D ACT System

AK-AC-II-TTM-V Acetabular Cup



AK-AC-II-TTM-V Acetabular Cup

Size Ref. (O.D./I.D.)	Cat. No.	Description	Matched Liner size (O.D./I.D.)	Matched Liner size (O.D./I.D.)	Matched Liner size (O.D./I.D.)	Matched Femoral Head Dia.
48/40	2321-4840	Name: AK-AC-II-TTM-V Acetabular Cup Material: Titanium Alloy Customized Supplied Surface: Titanium Trabecular Metal, 3D-geometric Structure Matched Liner: AK-L-II Liner HXLPE Matched Stem: AK-ML-TP, AK- ML-TH, AK-MP-TP, AK-MR, AK- SL, AK-MF, AK-SR	40/28	-	-	28
50/42	2321-5042		42/28	42/32	-	28/32
52/44	2321-5244		44/28	44/32	-	28/32
54/46	2321-5446		46/28	46/32	46/36	28/32/36
56/48	2321-5648		48/28	48/32	48/36	28/32/36
58/50	2321-5850		50/28	50/32	50/36	28/32/36
60/52	2321-6052		52/28	52/32	52/36	28/32/36
62/54	2321-6254		54/28	54/32	54/36	28/32/36
64/54	2321-6454		54/28	54/32	54/36	28/32/36
66/58	2321-6658		-	58/32	58/36	32/36
68/58	2321-6858	-	58/32	58/36	32/36	
70/60	2321-7060	-	60/32	60/36	32/36	

3D ACT System

Titanium Trabecular Augment



Titanium Trabecular Augment

Size Ref.	Cat. No.	Description	Thickness	Matched Cups Outer Dia.
50/40	5001-5040	Name: Titanium Trabecular Augment Material: Titanium Alloy Customized Supplied Surface: Titanium Trabecular Metal, 3D-geometric Structure	15	50, 52
52/42	5001-5242		25	50, 52
54/44	5001-5444		15	54, 56
56/46	5001-5646		25	54, 56
58/48	5001-5848		15	58, 60
60/50	5001-6050		25	58, 60
62/52	5001-6252		15	62, 64
64/54	5001-6454		25	62, 64
66/56	5001-6656		15	66, 68
68/58	5001-6858		25	66, 68

Titanium Trabecular Augment

Type	Size Ref.	Cat. No.	Description
RTX	38/40×10	5002-3810	Name: Titanium Trabecular Augment (RTX) Material: Titanium Alloy Customized Supplied Surface: Titanium Trabecular Metal, 3D-geometric Structure
	42/44×10	5002-4210	
	42/44×15	5002-4215	
	46/48×10	5002-4610	
	46/48×15	5002-4615	
	46/48×20	5002-4620	
	50/52×10	5002-5010	
	50/52×15	5002-5015	
	50/52×20	5002-5020	
	50/52×30	5002-5030	
	54/56×10	5002-5410	
	54/56×15	5002-5415	
	54/56×20	5002-5420	
	54/56×30	5002-5430	
	58/60×10	5002-5810	
	58/60×15	5002-5815	
	58/60×20	5002-5820	
	58/60×30	5002-5830	
	62/64×10	5002-6210	
	62/64×15	5002-6215	
	62/64×20	5002-6220	
	62/64×30	5002-6230	
	66/68×10	5002-6610	
	66/68×15	5002-6615	
	66/68×20	5002-6620	
66/68×30	5002-6630		
70/72×10	5002-7010		
70/72×15	5002-7015		
70/72×20	5002-7020		
70/72×30	5002-7030		



Type	Size Ref.	Cat. No.	Description
RTX-III	50/52×10	A2510-5010	Name: Titanium Trabecular Augment (RTX-III) Material: Titanium Alloy Customized Supplied Surface: Titanium Trabecular Metal, 3D-geometric Structure
	50/52×15	A2510-5015	
	50/52×20	A2510-5020	
	50/52×25	A2510-5025	
	54/56×10	A2510-5410	
	54/56×15	A2510-5415	
	54/56×20	A2510-5420	
	54/56×25	A2510-5425	
	58/60×10	A2510-5810	
	58/60×15	A2510-5815	
	58/60×20	A2510-5820	
	58/60×25	A2510-5825	



Type	Size Ref.	Cat. No.	Description
BTS	56	A2500-5600	Name: Titanium Trabecular Augment (BTS) Material: Titanium Alloy Customized Supplied Surface: Titanium Trabecular Metal, 3D-geometric Structure
	62	A2500-6200	
	68	A2500-6800	
	56L	A2500-5601	
	62L	A2500-6201	
	68L	A2500-6801	
	56R	A2500-5602	
	62R	A2500-6202	
	68R	A2500-6802	



Type	Size Ref.	Cat. No.	Description
BTS-II	58RL	A2511-5802	Name: Titanium Trabecular Augment (BTS-II) Material: Titanium Alloy Customized Supplied Surface: Titanium Trabecular Metal, 3D-geometric Structure
	58RS	A2511-5805	
	66RL	A2511-6602	
	66RS	A2511-6605	
	58CL	A2511-5800	
	58CS	A2511-5803	
	66CL	A2511-6600	
	66CS	A2511-6603	
	58LL	A2511-5801	
	58LS	A2511-5804	
	66LL	A2511-6601	
	66LS	A2511-6604	



Type	Size Ref.	Cat. No.	Description
SHM	4/0°	A2501-0400	Name: Titanium Trabecular Augment (SHM) Material: Titanium Alloy Customized Supplied Surface: Titanium Trabecular Metal, 3D-geometric Structure
	4/5°	A2501-0405	
	4/10°	A2501-0410	
	4/15°	A2501-0415	



Type	Size Ref.	Cat. No.	Description
SHM	4/0°S	A2700-0400	Name: Titanium Trabecular Augment (SHM) Material: Titanium Alloy Customized Supplied Surface: Titanium Trabecular Metal, 3D-geometric Structure
	4/5°S	A2700-0405	
	4/10°S	A2700-0410	
	4/15°S	A2700-0415	



Type	Size Ref.	Cat. No.	Description
RES	26mm	A2503-0026	Name: Titanium Trabecular Augment (RES) Material: Titanium Alloy Customized Supplied Surface: Titanium Trabecular Metal, 3D-geometric Structure
	32mm	A2503-0032	
	38mm	A2503-0038	
	44mm	A2503-0044	

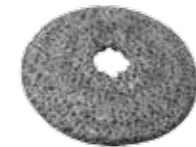

Type	Size Ref.	Cat. No.	Description
RES	20mmM	A2514-2002	Name: Titanium Trabecular Augment (RES) Material: Titanium Alloy Customized Supplied Surface: Titanium Trabecular Metal, 3D-geometric Structure
	25mmM	A2514-2502	
	30mmM	A2514-3002	
	35mmM	A2514-3502	



Type	Size Ref.	Cat. No.	Description
RES-II	26×5	A2513-2605	Name: Titanium Trabecular Augment (RES-II) Material: Titanium Alloy Customized Supplied Surface: Titanium Trabecular Metal, 3D-geometric Structure
	26×8	A2513-2608	
	32×5	A2513-3205	
	32×8	A2513-3208	



TITAN

Artificial Vertebral Body

- The structure that imitates bone Trabecular Titanium. 80% porosity, 800±200µm pore size. Optimal cell migration and proliferation. Increased production of BMP and anti-inflammatory cytokines.
- Modulus of elasticity close to cancellous bone avoids stress shielding and bone resorption, prevents endplate collapse.
- Biocompatibility and reliable osseointegration.
- Porous surface provides excellent primary stability.



- Curved-shape design with maximum endplate contact, prevents endplate collapse.
- Cervical vertebra: Height 12-90mm, in 2mm increments; Diameter 12/14mm.
- Thoracic&Lumbar vertebra: Height 25-120mm, in 5/10mm increments; Diameter 12*18mm~18*24mm.
- 3 lordosis angles for multiple orthopedic designs.
- Preserved bone graft windows if bone graft is required.

Cervical Vertebra

Angle	0°, 4°, 8°	
Height	12mm~90mm, in 2mm increment	
Specification	ML (mm)	AP (mm)
	12	10
	14	12

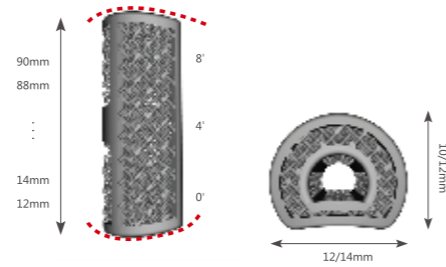

Thoracic&Lumbar Vertebra

Angle	0°, 4°, 8°	
Height	25mm~60mm, in 5mm increment	
	60mm~120mm, in 10mm increment	
Specification	ML (mm)	AP (mm)
	18	12
	19	13
	20	14
	21	15
	22	16
	23	17
	24	18

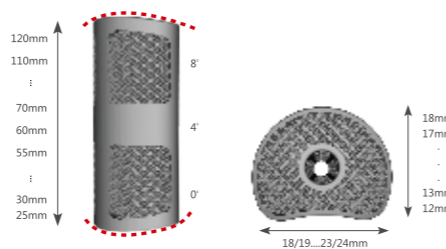

METIS

Artificial Cervical Cage

- Curved-shape design with maximum endplate contact, prevents endplate collapse.
- ML 15mm, AP 12.5mm, wedge-shape, curved-shape.
- 6 heights in 1mm increment, 5~10mm.
- 3 lordosis angles for multiple orthopedic designs.
- Preserved bone graft windows if bone graft is required.

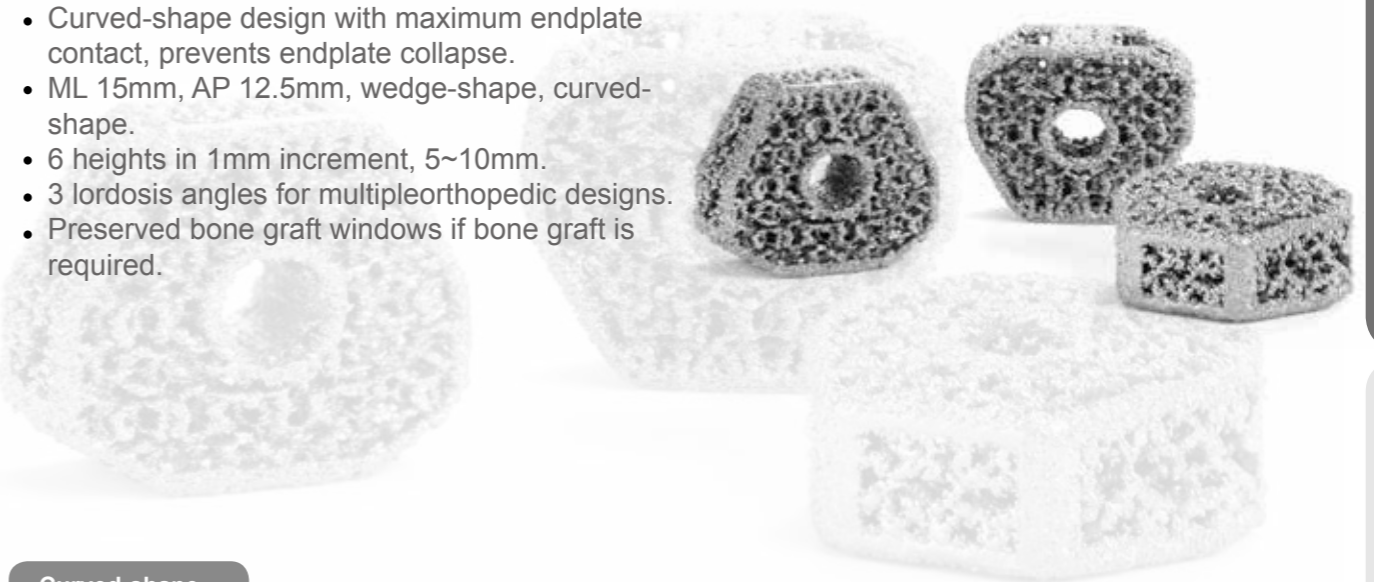

Curved-shape

Cat. No. (0°)	Cat. No. (4°)	Cat. No. (8°)	Height (mm)	ML(mm)	AP(mm)
5025-0405	5025-0445	5025-0485	5	15	12.5
5025-0406	5025-0446	5025-0486	6	15	12.5
5025-0407	5025-0447	5025-0487	7	15	12.5
5025-0408	5025-0448	5025-0488	8	15	12.5
5025-0409	5025-0449	5025-0489	9	15	12.5
5025-0400	5025-0440	5025-0480	10	15	12.5

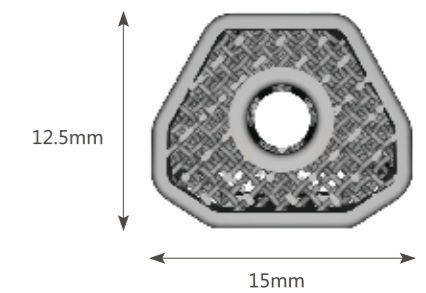

Wedge-shape

Cat. No. (0°)	Cat. No. (4°)	Cat. No. (8°)	Height (mm)	ML(mm)	AP(mm)
5025-0205	5025-0245	5025-0285	5	15	12.5
5025-0206	5025-0246	5025-0286	6	15	12.5
5025-0207	5025-0247	5025-0287	7	15	12.5
5025-0208	5025-0248	5025-0288	8	15	12.5
5025-0209	5025-0249	5025-0289	9	15	12.5
5025-0200	5025-0240	5025-0280	10	15	12.5

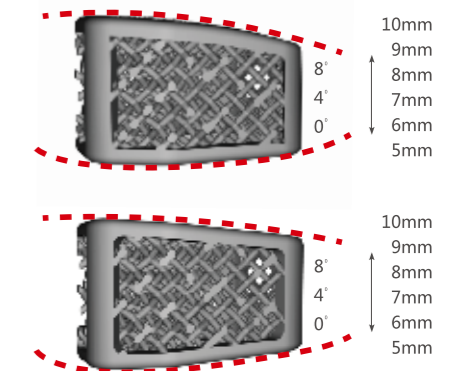

Knee System

A3 Primary Total Knee System

- A3 fix bearing knee system is to provide sufficient articular surface and proper patella tracking as well as rotational freedom to accommodate deep knee flexion up to 145 degree;
- 12 Femoral sizes and 13 tibial sizes provide the best fitting combination;
- Ingenuity curvature design makes sure that any sizes of femoral condylar and tibial insert matches with each other;
- Deep and extended patella groove improves the patella trackability;
- Bolt-locking mechanism gives loosening zero chance.

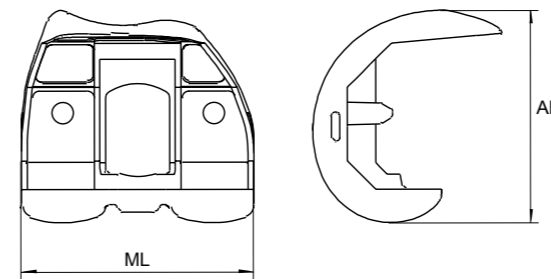
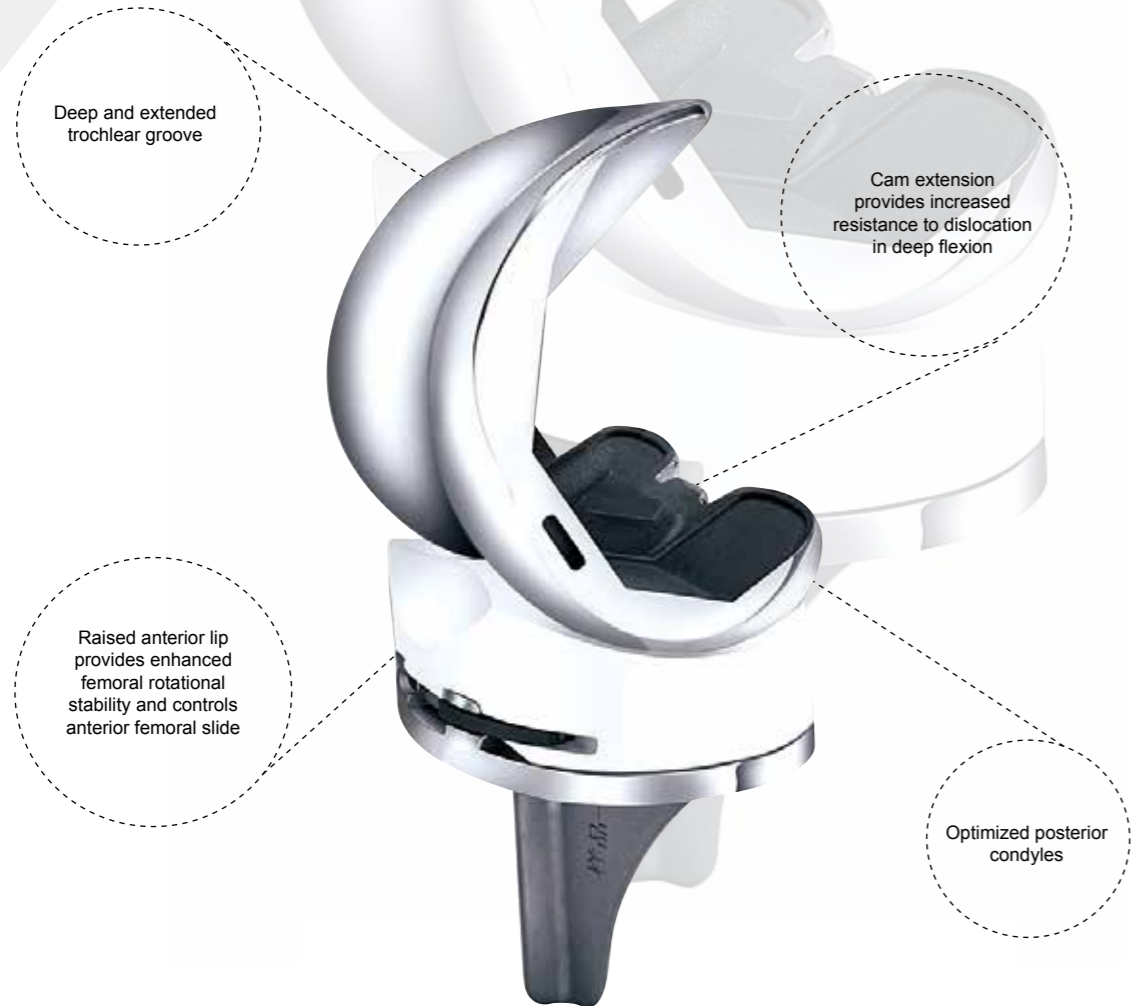

A3 Femoral Condylar (Co-Cr-Mo)

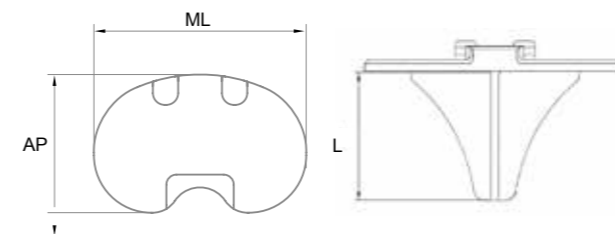

A3 Fixed Tibial Tray (Co-Cr-Mo)

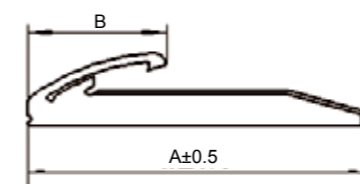

A3 Locking Clip (Titanium Alloy)

A3 Femoral Condylar

Size Ref.	Cat. No.	Description	ML X AP (mm)	
LS1#	6916-1401	Name:A3 Femoral Condylar Regularly Supplied	50 X 45	
LS2#	6916-1402		53 X 49	
L1#	6916-1410		56 X 52	
L1.5#	6916-1415		59 X 54	
L2#	6916-1420		62 X 57	
L2.5#	6916-1425		64 X 59	
L3#	6916-1430		67 X 61	
L3.5#	6916-1435	Material: Co-Cr-Mo Side Refer: Left	69 X 64	
L4#	6916-1440		72 X 66	
L5#	6916-1450		74 X 68	
L6#	6916-1460		79 X 72	
L7#	6916-1470		84 X 76	
RS1#	6916-1301		Name: A3 Femoral Condylar Regularly Supplied	50 X 45
RS2#	6916-1302			53 X 49
R1#	6916-1310	56 X 52		
R1.5#	6916-1315	59 X 54		
R2#	6916-1320	62 X 57		
R2.5#	6916-1325	64 X 59		
R3#	6916-1330	67 X 61		
R3.5#	6916-1335	Material: Co-Cr-Mo Side Refer: Right	69 X 64	
R4#	6916-1340		72 X 66	
R5#	6916-1350		74 X 68	
R6#	6916-1360		79 X 72	
R7#	6916-1370		84 X 76	

A3 Fixed Tibial Tray

Size Ref.	Cat. No.	Description	ML X AP (mm)	Height L (mm)	
S	7107-0001	Name: A3 Fixed Tibial Tray Regularly Supplied	54 x 36	35	
A	7107-0002		59 x 38	40	
B	7107-0003		63 x 41	40	
B+	7107-0013		65 x 42	40	
C	7107-0004		67 x 43	40	
C+	7107-0014		69 x 45	40	
D	7107-0005		71 x 46	40	
D+	7107-0015		73 x 47	40	
E	7107-0006		Material: Co-Cr-Mo	75 x 48	40
F	7107-0007			79 x 51	40
G	7107-0008	83 x 53		40	
H	7107-0009	87 x 56		40	
L	7107-0010		91 x 58	40	

A3 Locking Clip

Size Ref.	Cat. No.	A	B
S	7802-0001	45.5	18.5
M	7802-0002	49	20

A3 PS Tibial Insert

Size Ref.	Cat. No.	Description	ML X AP (mm)	Thickness (mm)	Tibial Tray	C Width (mm)	D Height (mm)
SA#8mm	7222-1008	Name: A3 PS Tibial Insert Regularly Supplied Material: UHMWPE	54 x 35	6	S, A	16	26
SA#10mm	7222-1010		54 x 35	8		16	28
SA#12mm	7222-1012		54 x 35	10		16	30
SA#14mm	7222-1014		54 x 35	12		16	32
SA#16mm	7222-1016		54 x 35	14	16	34	
BC#8mm	7222-1508		B, B+, C, C+	63 x 40	6	16	26
BC#10mm	7222-1510			63 x 40	8	16	28
BC#12mm	7222-1512			63 x 40	10	16	30
BC#14mm	7222-1514			63 x 40	12	16	32
BC#16mm	7222-1516		63 x 40	14	16	34	
DE#8mm	7222-2008		D, D+, E	71 x 45	6	16	26
DE#10mm	7222-2010			71 x 45	8	16	28
DE#12mm	7222-2012			71 x 45	10	16	30
DE#14mm	7222-2014			71 x 45	12	16	32
DE#16mm	7222-2016		71 x 45	14	16	34	
FG#8mm	7222-2508		F, G	79 x 50	6	16	26
FG#10mm	7222-2510	79 x 50		8	16	28	
FG#12mm	7222-2512	79 x 50		10	16	30	
FG#14mm	7222-2514	79 x 50		12	16	32	
FG#16mm	7222-2516	79 x 50	14	16	34		
HL#8mm	7222-3008	H, L	87 x 55	6	16	26	
HL#10mm	7222-3010		87 x 55	8	16	28	
HL#12mm	7222-3012		87 x 55	10	16	30	
HL#14mm	7222-3014		87 x 55	12	16	32	
HL#16mm	7222-3016	87 x 55	14	16	34		

A3 PS Plus Tibial Insert

Size Ref.	Cat. No.	Description	ML X AP (mm)	Thickness (mm)	Tibial Tray	C Width (mm)	D Height (mm)
SA#8mm	7223-1008	Name: A3 PS Plus Tibial Insert Regularly Supplied Material: UHMWPE	54 x 35	6	S, A	16.5	26
SA#10mm	7223-1010		54 x 35	8		16.5	28
SA#12mm	7223-1012		54 x 35	10		16.5	30
SA#14mm	7223-1014		54 x 35	12		16.5	32
SA#16mm	7223-1016		54 x 35	14	16.5	34	
BC#8mm	7223-1508		B, B+, C, C+	63 x 40	6	16.5	26
BC#10mm	7223-1510			63 x 40	8	16.5	28
BC#12mm	7223-1512			63 x 40	10	16.5	30
BC#14mm	7223-1514			63 x 40	12	16.5	32
BC#16mm	7223-1516		63 x 40	14	16.5	34	
DE#8mm	7223-2008		D, D+, E	71 x 45	6	16.5	26
DE#10mm	7223-2010			71 x 45	8	16.5	28
DE#12mm	7223-2012			71 x 45	10	16.5	30
DE#14mm	7223-2014			71 x 45	12	16.5	32
DE#16mm	7223-2016		71 x 45	14	16.5	34	
FG#8mm	7223-2508		F, G	79 x 50	6	16.5	26
FG#10mm	7223-2510	79 x 50		8	16.5	28	
FG#12mm	7223-2512	79 x 50		10	16.5	30	
FG#14mm	7223-2514	79 x 50		12	16.5	32	
FG#16mm	7223-2516	79 x 50	14	16.5	34		
HL#8mm	7223-3008	H, L	87 x 55	6	16.5	26	
HL#10mm	7223-3010		87 x 55	8	16.5	28	
HL#12mm	7223-3012		87 x 55	10	16.5	30	
HL#14mm	7223-3014		87 x 55	12	16.5	32	
HL#16mm	7223-3016	87 x 55	14	16.5	34		



PS Tibial Insert (UHMWPE)

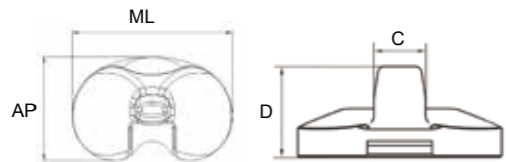

PS Plus Tibial Insert (UHMWPE)

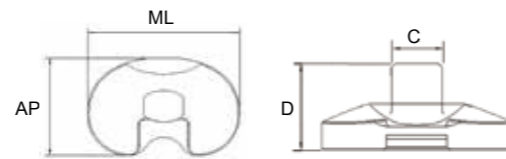

A3 Patella (UHMWPE)

A3 Patella

Size Ref.	Cat. No.	Description	Diameter D(mm)	Thickness T(mm)
Small	7303-1701	Name: A3 Patella	27	7
Medium	7303-1702	Regularly Supplied	31	8
Large	7303-1703	Material: UHMWPE	34	9

A3 GT Personalized Total Knee System

- Both CR and PS knee available;
- Open intercondylar design on CR and PS condylar reduces bone resection;
- Anatomical tibia tray compatible with both CR and PS insert;
- Anatomical prosthesis best adjustable to human body for all races in the world;
- Precise, simple, practical and user-friendly instruments dedicated for surgeons.



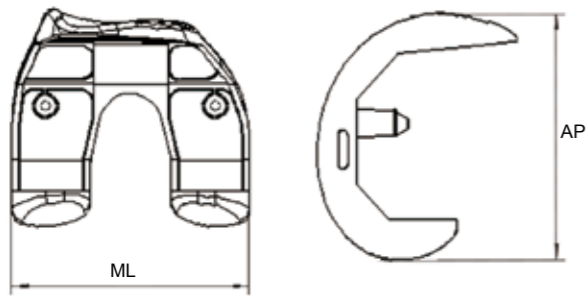

A3 GT CR Femoral Condylar (Co-Cr-Mo)

A3 GT CR Femoral Condylar

Size Ref.	Cat. No.	Description	ML X AP (mm)
L1#	6914-1410	Name:A3 GT CR Femoral Condylar Regularly Supplied	56 X 52
L1.5#	6914-1415		59 X 54
L2#	6914-1420		62 X 57
L2.5#	6914-1425		64 X 59
L3#	6914-1430		67 X 61
L3.5#	6914-1435		69 X 64
L4#	6914-1440		Material: Co-Cr-Mo Side Refer: Left
L5#	6914-1450		74 X 68
L6#	6914-1460		79 X 72
L7#	6914-1470		84 X 76
R1#	6914-1310	Name: A3 GT CR Femoral Condylar Regularly Supplied	52 X 56
R1.5#	6914-1315		54 X 59
R2#	6914-1320		57 X 62
R2.5#	6914-1325		59 X 64
R3#	6914-1330		61 X 67
R3.5#	6914-1335		64 X 69
R4#	6914-1340		Material: Co-Cr-Mo Side Refer: Right
R5#	6914-1350		68 X 74
R6#	6914-1360		79 X 72
R7#	6914-1370		84 X 76

A3 GT PS Femoral Condylar

Refer to A3 Femoral Condylar on Page 13

A3 Patella

Refer to A3 Patella on Page 14



A3 Patella (UHMWPE)

A3 GT Tibial Tray

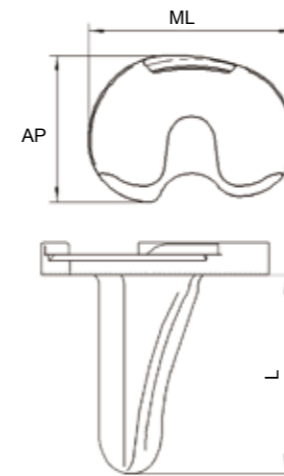

A3 GT Tibial Tray (Co-Cr-Mo)

Size Ref.	Cat. No.	Description	ML X AP (mm)	Height L (mm)	
LS	A1229-1001	Name: A3 GT Tibial Tray Regularly Supplied	54 X 39	35	
LA	A1229-1002		59 X 42	40	
LB	A1229-1003		63 X 45	40	
LB+	A1229-1013		65 X 46	40	
LC	A1229-1004		67 X 47	40	
LC+	A1229-1014		69 X 49	40	
LD	A1229-1005		Material: Co-Cr-Mo Side Refer: Left	71 X 51	40
LD+	A1229-1015		73 X 52	40	
LE	A1229-1006		79 X 53	40	
LF	A1229-1007		79 X 56	40	
LG	A1229-1008		83 X 61	40	
RS	A1229-2001		Name: A3 GT Tibial Tray Regularly Supplied	54 X 39	35
RA	A1229-2002			59 X 42	40
RB	A1229-2003			63 X 45	40
RB+	A1229-2013	65 X 46		40	
RC	A1229-2004	67 X 47		40	
RC+	A1229-2014	69 X 49		40	
RD	A1229-2005	Material: Co-Cr-Mo Side Refer: Right		71 X 51	40
RD+	A1229-2015	73 X 52		40	
RE	A1229-2006	79 X 53		40	
RF	A1229-2007	79 X 56		40	
RG	A1229-2008	83 X 61	40		

A3 GT PS Tibial Insert

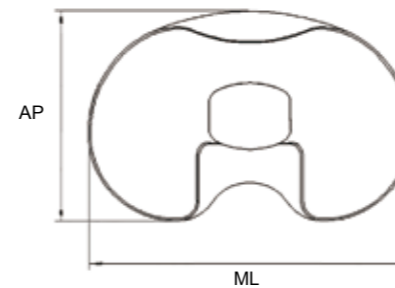

A3 GT PS Tibial Insert (UHMWPE)

Size Ref.	Cat. No.	Description	ML X AP (mm)	Tibial Tray
SA#8mm	A1328-1008	Name: A3 GT PS Tibial Insert Regularly Supplied	54 X 36	S, A
SA#10mm	A1328-1010		54 X 36	
SA#12mm	A1328-1012		54 X 36	
SA#14mm	A1328-1014		54 X 36	
SA#16mm	A1328-1016		54 X 36	B, B+, C, C+
BC#8mm	A1328-1508		63 X 40	
BC#10mm	A1328-1510		63 X 40	
BC#12mm	A1328-1512		63 X 40	
BC#14mm	A1328-1514		63 X 40	D, D+, E
BC#16mm	A1328-1516		63 X 40	
DE#8mm	A1328-2008		71 X 46	
DE#10mm	A1328-2010		71 X 46	
DE#12mm	A1328-2012		71 X 46	
DE#14mm	A1328-2014		71 X 46	
DE#16mm	A1328-2016		71 X 46	
FG#8mm	A1328-2508		79 X 51	
FG#10mm	A1328-2510	79 X 51		
FG#12mm	A1328-2512	79 X 51		
FG#14mm	A1328-2514	79 X 51		
FG#16mm	A1328-2516	79 X 51		

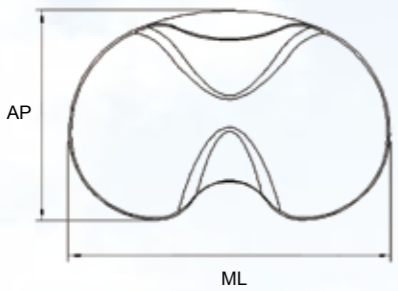
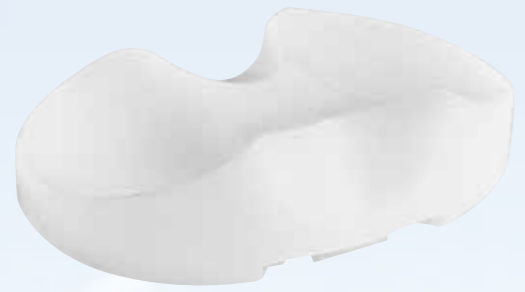

A3 GT Deep Dish Tibial Insert (UHMWPE)

A3 GT Deep Dish Tibial Insert

Size Ref.	Cat. No.	Description	ML X AP (mm)	Tibial Tray
SA#8mm	A1332-1008	Name: A3 GT Deep Dish Tibial Insert Regularly Supplied Material: UHMWPE	54 X 36	S, A
SA#10mm	A1332-1010		54 X 36	
SA#12mm	A1332-1012		54 X 36	
SA#14mm	A1332-1014		54 X 36	
SA#16mm	A1332-1016		54 X 36	
BC#8mm	A1332-1508		63 X 40	
BC#10mm	A1332-1510		63 X 40	
BC#12mm	A1332-1512		63 X 40	
BC#14mm	A1332-1514		63 X 40	
BC#16mm	A1332-1516		63 X 40	
DE#8mm	A1332-2008		71 X 46	D, D+, E
DE#10mm	A1332-2010		71 X 46	
DE#12mm	A1332-2012		71 X 46	
DE#14mm	A1332-2014		71 X 46	
DE#16mm	A1332-2016		71 X 46	
FG#8mm	A1332-2508		79 X 51	
FG#10mm	A1332-2510	79 X 51		
FG#12mm	A1332-2512	79 X 51		
FG#14mm	A1332-2514	79 X 51		
FG#16mm	A1332-2516	79 X 51		

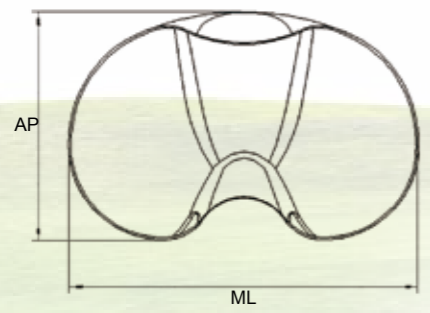

A3 GT CR Tibial Insert (UHMWPE)

A3 GT CR Tibial Insert

Size Ref.	Cat. No.	Description	ML X AP (mm)	Tibial Tray
SA#8mm	A1330-1008	Name: A3 GT CR Tibial Insert Regularly Supplied Material: UHMWPE	54 X 36	S, A
SA#10mm	A1330-1010		54 X 36	
SA#12mm	A1330-1012		54 X 36	
SA#14mm	A1330-1014		54 X 36	
SA#16mm	A1330-1016		54 X 36	
BC#8mm	A1330-1508		63 X 40	
BC#10mm	A1330-1510		63 X 40	
BC#12mm	A1330-1512		63 X 40	
BC#14mm	A1330-1514		63 X 40	
BC#16mm	A1330-1516		63 X 40	
DE#8mm	A1330-2008		71 X 46	D, D+, E
DE#10mm	A1330-2010		71 X 46	
DE#12mm	A1330-2012		71 X 46	
DE#14mm	A1330-2014		71 X 46	
DE#16mm	A1330-2016		71 X 46	
FG#8mm	A1330-2508		79 X 51	
FG#10mm	A1330-2510	79 X 51		
FG#12mm	A1330-2512	79 X 51		
FG#14mm	A1330-2514	79 X 51		
FG#16mm	A1330-2516	79 X 51		

JPX Total Knee System

- JPX provides for personalized patient care by allowing a custom-fit of the femoral, tibial and patellar components independently, thus addressing the largest possible percentage of the population;
- Proportional Posterior Condylars allows for optimal contact area in deep flexion;
- Wide Proximal Trochlear Groove provides excellent patellar tracking;
- Deep Trochlear Groove reduces patellar forces throughout range of motion;
- Optimized Tibiofemoral Articulation increased contact area in high flexion and axial rotation;
- 6 femoral components that grow anterior/posterior on average by 2.4mm increments.

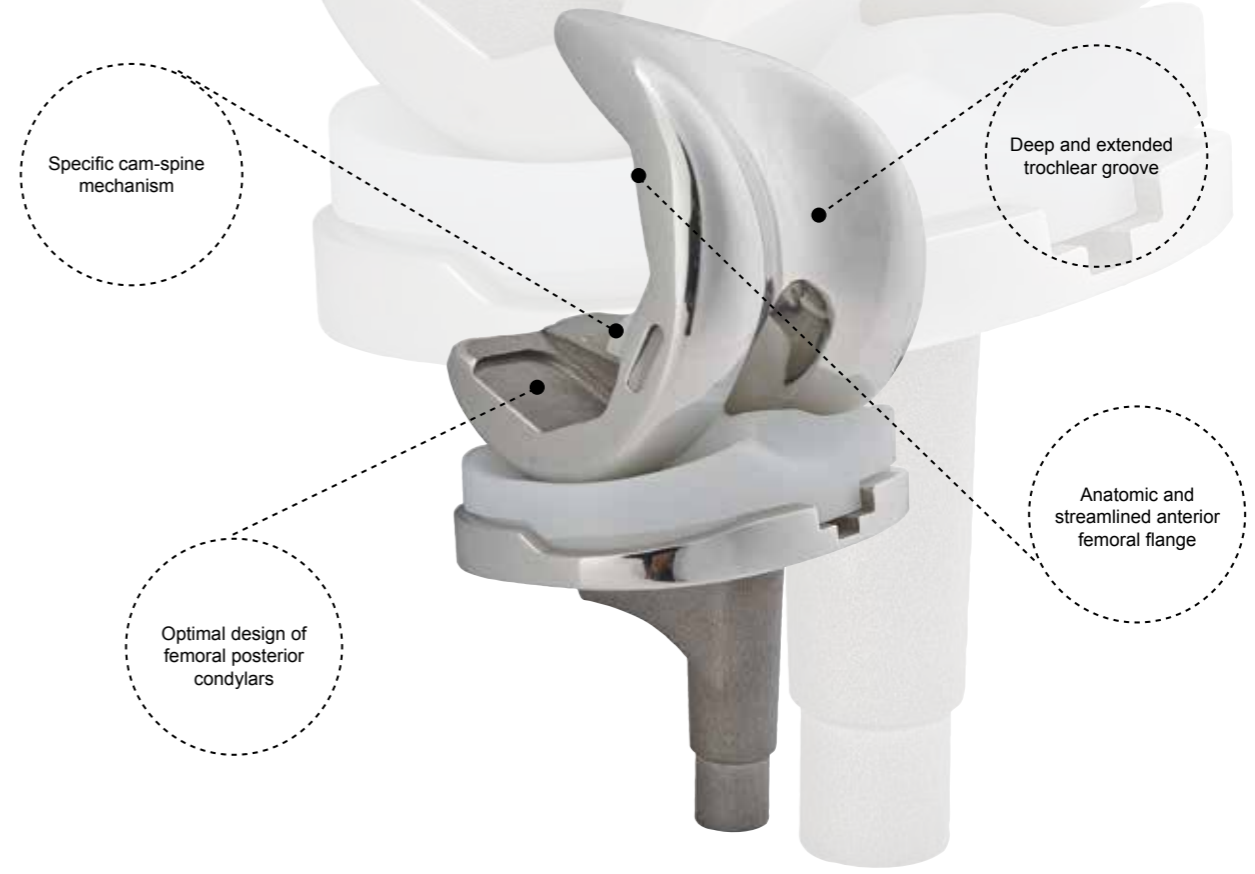

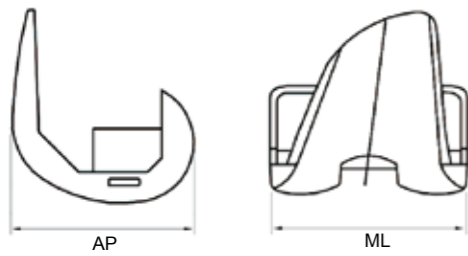

JPX Femoral Condylar
(Co-Cr-Mo)

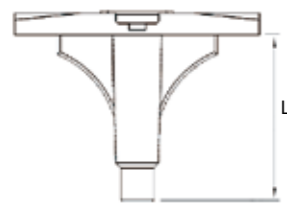
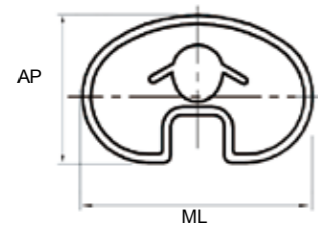

JPX Fixed Tibial Tray
(Co-Cr-Mo)

JPX Femoral Condylar

Size Ref.	Cat. No.	Description	ML X AP (mm)
L1#	6912-1401	Name: JPX Femoral Condylar Regularly Supplied Material: Co-Cr-Mo Side Refer: Left	62 x 52
L2#	6912-1402		65 x 56
L2.5#	6912-1425		67.5 x 57.5
L3#	6912-1403		70 x 59
L3.5#	6912-1435		72 x 60.5
L4#	6912-1404		74 x 62
L5#	6912-1405	75 x 65	
L6#	6912-1406	78 x 68	
R1#	6912-1301	Name: JPX Femoral Condylar Regularly Supplied Material: Co-Cr-Mo Side Refer: Right	62 x 52
R2#	6912-1302		65 x 56
R2.5#	6912-1325		67.5 x 57.5
R3#	6912-1303		70 x 59
R3.5#	6912-1335		72 x 60.5
R4#	6912-1304		74 x 62
R5#	6912-1305	75 x 65	
R6#	6912-1306	78 x 68	

JPX Fixed Tibial Tray

Size Ref.	Cat. No.	Description	ML X AP (mm)	Height L (mm)
1#	7101-1601	Name: JPX Fixed Tibial Tray Regularly Supplied Material: Co-Cr-Mo	62 x 37	40
1+	7101-1611		64 x 39	40
2#	7101-1602		66 x 42	40
2+	7101-1612		69 x 45	40
3#	7101-1603		72 x 48	50
3+	7101-1613		74 x 50	50
4#	7101-1604	77 x 53	50	

JPX Tibial Insert

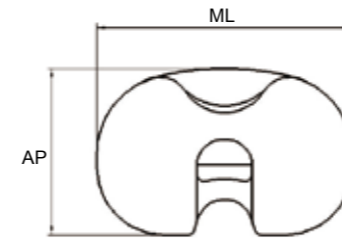

JPX Tibial Insert
(UHMWPE)

Size Ref.	Cat. No.	Description	Thickness (mm)	ML X AP (mm)	Tibial Tray
1#8mm	7214-1508	Name: JPX Tibial Insert Regularly Supplied Material: UHMWPE	6	62 x 37	1#, 1+
1#10mm	7214-1510		8	62 x 37	
1#12mm	7214-1512		10	62 x 37	
1#15mm	7214-1515		13	62 x 37	2#, 2+
2#8mm	7214-2508		6	66 x 42	
2#10mm	7214-2510		8	66 x 42	
2#12mm	7214-2512		10	66 x 42	
2#15mm	7214-2515		13	66 x 42	3#, 3+
3#8mm	7214-3508		6	72 x 47	
3#10mm	7214-3510		8	72 x 47	
3#12mm	7214-3512		10	72 x 47	
3#15mm	7214-3515		13	72 x 47	4#, 4+
4#8mm	7214-4508		6	77 x 53	
4#10mm	7214-4510		8	77 x 53	
4#12mm	7214-4512		10	77 x 53	
4#15mm	7214-4515	13	77 x 53		

JPX Patella



JPX Patella
(UHMWPE)

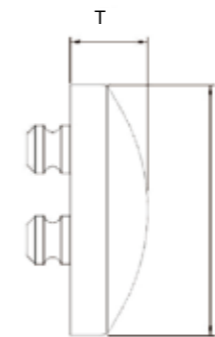

Size Ref.	Cat. No.	Description	Diameter D(mm)	Thickness T(mm)
Small	7301-1701	Name: JPX Patella Regularly Supplied Material: UHMWPE	27	9
Medium	7301-1702		29	9

ACCK Revision Knee System

- ACCK is intended for patients who, in the surgeon's judgment, require additional prosthetic stabilization due to inadequate mediolateral, anteroposterior, and varus/valgus ligament function, and require augmentation and/or stem extensions due to inadequate bone stock;
- For use when both cruciate ligaments are excised and when greater varus/valgus constraint is required;
- ACCK can be used with augments and stem extensions, provides for personalized patient care by allowing a custom-fit of the femoral, tibial and patellar components independently, thus addressing the largest possible percentage of the population;
- High flexion up to 145 degree;
- Intraoperative flexibility with cylinder and offset extension stem;
- Ingenuity curvature design make sure any size of femoral implant fits with any size of tibial insert;
- Individual femoral and tibial augments with two different thicknesses;
- Bolt-Locking mechanism gives loosening zero chances.

Straight & Offset stems with different diameter and length options



Intraoperative flexibility with two stem options: straight and offset



Individual distal and posterior femoral augments with two thickness options

Tibial augment with two thickness options



ACCK Femoral Condylar

Size Ref.	Cat. No.	Description	ML X AP (mm)
L1#	6915-1410	Name: ACCK Femoral Condylar Regularly Supplied Material: Co-Cr-Mo	56 X 52
L2#	6915-1420		62 X 57
L3#	6915-1430		67 X 61
L4#	6915-1440		72 X 66
L5#	6915-1450		74 X 68
R1#	6915-1310		56 X 52
R2#	6915-1320		62 X 57
R3#	6915-1330		67 X 61
R4#	6915-1340		72 X 66
R5#	6915-1350		74 X 68

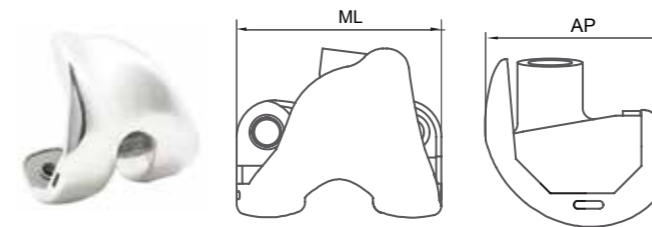

ACCK Femoral Condylar (Co-Cr-Mo)

ACCK Tibial Tray

Size Ref.	Cat. No.	Description	ML X AP (mm)
A	7106-0002	Name: ACCK Tibial Tray Regularly Supplied Material: Co-Cr-Mo	59 X 38
B	7106-0003		63 X 41
C	7106-0004		67 X 43
D	7106-0005		71 X 46
E	7106-0006		75 X 48

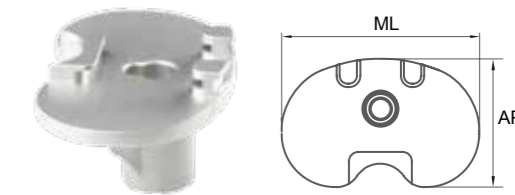

ACCK Tibial Tray (Co-Cr-Mo)

ACCK Tibial Insert

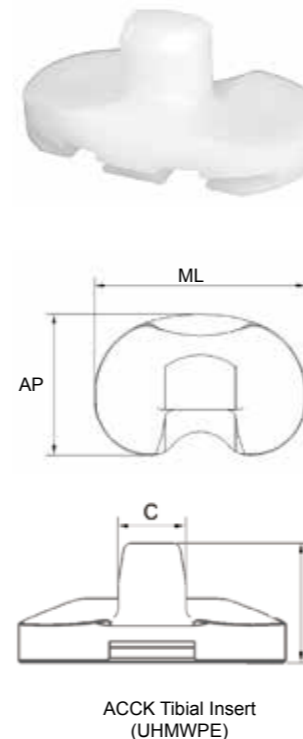

ACCK Tibial Insert (UHMWPE)

Size Ref.	Cat. No.	Description	ML X AP (mm)	Tibial Tray	C Width (mm)	D Height (mm)
SA10mm	7224-1010	Name: ACCK Tibial Insert Regularly Supplied Material: UHMWPE	54 x 35	A	18.2	31
SA12mm	7224-1012		54 x 35		18.2	33
SA14mm	7224-1014		54 x 35		18.2	35
SA16mm	7224-1016		54 x 35		18.2	37
SA18mm	7224-1018		54 x 35		18.2	39
SA20mm	7224-1020		54 x 35		18.2	41
SA22mm	7224-1022		54 x 35	18.2	43	
BC10mm	7224-1510		63 x 40	B, C	18.2	31
BC12mm	7224-1512		63 x 40		18.2	33
BC14mm	7224-1514		63 x 40		18.2	35
BC16mm	7224-1516		63 x 40		18.2	37
BC18mm	7224-1518		63 x 40		18.2	39
BC20mm	7224-1520		63 x 40		18.2	41
BC22mm	7224-1522		63 x 40	18.2	43	
DE10mm	7224-2010		71 x 45	D, E	18.2	31
DE12mm	7224-2012		71 x 45		18.2	33
DE14mm	7224-2014		71 x 45		18.2	35
DE16mm	7224-2016		71 x 45		18.2	37
DE18mm	7224-2018		71 x 45		18.2	39
DE20mm	7224-2020		71 x 45		18.2	41
DE22mm	7224-2022		71 x 45	18.2	43	

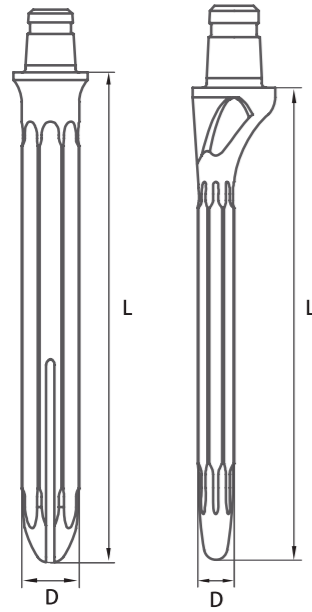

Straight and Offset Extension Stem (Titanium Alloy)

ACCK Extension Stem

Type	Cat. No.	Description	LengthxDia. (mm)
Straight	7403-8008	Name: ACCK Extension Stem Regularly Supplied Material: Titanium Alloy	80 x 8
	7403-8010		80 x 10
	7403-8012		80 x 12
	7404-8014		80 x 14
	7404-8016		80 x 16
	7404-8018		80 x 18
	7403-1208		120 x 8
	7403-1210		120 x 10
	7403-1212		120 x 12
	7404-1214		120 x 14
Offset	7405-8008	Name: ACCK Extension Stem Regularly Supplied Material: Titanium Alloy	80 x 8
	7405-8010		80 x 10
	7405-8012		80 x 12
	7405-8014		80 x 14
	7405-8016		80 x 16
	7405-8018		80 x 18
	7405-1208		120 x 8
	7405-1218		120 x 18

ACCK Locking Clip

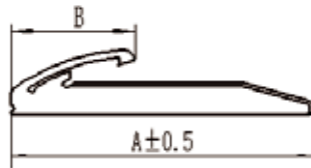

Size	Cat.No.	A	B
S	7802-0001	45.5	18.5
M	7802-0002	49	20



Distal Femoral Augment

Size Ref.	Cat. No.	Description	Thickness (mm)
1#5mm	7604-1005	Name: Distal Femoral Augment	5
1#10mm	7604-1010		10
2#5mm	7604-2005	Regularly Supplied	5
2#10mm	7604-2010		10
3#5mm	7604-3005	Material: Titanium Alloy	5
3#10mm	7604-3010		10
4#5mm	7604-4005		5
4#10mm	7604-4010	10	
5#5mm	7604-5005	5	
5#10mm	7604-5010	10	



Posterior Femoral Augment

Size Ref.	Cat. No.	Description	Thickness (mm)
1#5mm	7605-1005	Name: Posterior Femoral Augment	5
1#10mm	7605-1010		10
2#5mm	7605-2005	Regularly Supplied	5
2#10mm	7605-2010		10
3#5mm	7605-3005	Material: Titanium Alloy	5
3#10mm	7605-3010		10
4#5mm	7605-4005		5
4#10mm	7605-4010	10	
5#5mm	7605-5005	5	
5#10mm	7605-5010	10	



Tibial Augment

Size Ref.	Cat. No.	Description	Thickness (mm)
A 5mm	7703-1005	Name: Tibial Augment	5
A 10mm	7703-1010		10
B 5mm	7703-1505		5
B 10mm	7703-1510	Regularly Supplied	10
C 5mm	7703-2005		5
C 10mm	7703-2010	Material: Titanium Alloy	10
D 5mm	7703-2505		5
D 10mm	7703-2510		10
E 5mm	7703-3005		5
E 10mm	7703-3010		10

AK Hinge Knee System

- Loading mode approaches to the primary, 95% condylar loading through the tibial Tray;
- The central location of the AHK mechanism is placed closer to the axis of the tibial component, resulting in more natural and consistent tibio-femoral kinematics;
- The central location of the hinge axis keeps the femoral condyles in a consistent sagittal plane. This allows for more normal patellar tracking since the patella does not shift posteriorly during flexion;
- Femoral condylar takes advantage of A3 patella design, bone cuts from intercondylar are the same as those made for Primary Components. This helps to minimize bone loss.



The ratio of conformity between the femoral condyles and tibial articular surface is virtually 1 to 1.



AHK can be used with the 3D Trabecular Metal Tibial and Femoral Cones that address those most difficult bone-loss scenarios.



It allows up to 25 degrees of movement in internal and external rotation.



Flexible modular design



Locking mechanism design offers a maximum "jump height" of 42 mm.



AHK can use A3/ACCK system instruments to simplify surgery.



AHK Femoral Condylar

Size Ref.	Cat. No.	Description	ML X AP (mm)
0#/L	7904-1100	Name: AHK Femoral Condylar Regularly Supplied Material: Co-Cr-Mo	56 x 56
1#/L	7904-1101		58 x 58
2#/L	7904-1102		64 x 58
3#/L	7904-1103		72 x 60
0#/R	7904-1200		56 x 56
1#/R	7904-1201		58 x 58
2#/R	7904-1202		64 x 58
3#/R	7904-1203		72 x 60



AHK Femoral Condylar (Co-Cr-Mo)

AHK Tibial Tray

Size Ref.	Cat. No.	Description	ML X AP (mm)
1#	8005-1301	Name: AHK Tibial Tray Regularly Supplied Material: Co-Cr-Mo	59 x 38
2#	8005-1302		63 x 41
3#	8005-1303		67 x 43
4#	8005-1304		71 x 46
5#	8005-1305		75 x 48



AHK Tibial Tray (Co-Cr-Mo)

AHK Tibial Insert



AHK Tibial Insert (UHMWPE)

Size Ref.	Cat. No.	Description	ML X AP (mm)
0#8mm	8108-0208	Name: AHK Tibial Insert Regularly Supplied Material: UHMWPE	55 x 35
0#10mm	8108-0210		55 x 35
0#12mm	8108-0212		55 x 35
0#14mm	8108-0214		55 x 35
0#16mm	8108-0216		55 x 35
0#18mm	8108-0218		55 x 35
1#8mm	8108-1208		58 x 42
1#10mm	8108-1210		58 x 42
1#12mm	8108-1212		58 x 42
1#14mm	8108-1214		58 x 42
1#16mm	8108-1216		58 x 42
1#18mm	8108-1218		58 x 42
2#8mm	8108-2208		64 x 44
2#10mm	8108-2210		64 x 44
2#12mm	8108-2212		64 x 44
2#14mm	8108-2214		64 x 44
2#16mm	8108-2216		64 x 44
2#18mm	8108-2218		64 x 44
3#8mm	8108-3208		72 x 46
3#10mm	8108-3210		72 x 46
3#12mm	8108-3212		72 x 46
3#14mm	8108-3214		72 x 46
3#16mm	8108-3216		72 x 46
3#18mm	8108-3218		72 x 46

AHK Extension Stem



AHK Extension Stem (Titanium Alloy)

Type	Cat. No.	Description	LengthxDia. (mm)
IV	8661-3010	Name: AHK Extension Stem Regularly Supplied Material: Titanium Alloy	Φ10×30
	8661-6008		Φ8×60
	8661-6010		Φ10×60
	8661-6012		Φ12×60
	8661-6014		Φ14×60
	8661-6016		Φ16×60
	8661-6018		Φ18×60
	8661-8008		Φ8×80
	8661-8010		Φ10×80
	8661-8012		Φ12×80
	8661-8014		Φ14×80
	8661-8016		Φ16×80
	8661-8018		Φ18×80

Distal Femoral Augment



Distal Femoral Augment (Titanium Alloy)

Size Ref.	Cat. No.	Description	Thickness (mm)
1#5mm	8300-1105	Name: Distal Femoral Augment Regularly Supplied Material: Titanium Alloy	5
1#10mm	8300-1110		10
2#5mm	8300-2105		5
2#10mm	8300-2110		10
3#5mm	8300-3105		5
3#10mm	8300-3110		10

Posterior Femoral Augment



Posterior Femoral Augment (Titanium Alloy)

Size Ref.	Cat. No.	Description	Thickness (mm)
1#5mm	8301-1105	Name: Posterior Femoral Augment Regularly Supplied Material: Titanium Alloy	5
1#10mm	8301-1110		10
2#5mm	8301-2105		5
2#10mm	8301-2110		10
3#5mm	8301-3105		5
3#10mm	8301-3110		10

Hip System

AK Femoral Stem

AK-ML-TP Femoral Stem

- Tapered Wedge design provides firm mediolateral stability within the femoral canal;
- Both 127° and 132° of Neck Shaft Angle are available;
- 24 sizes full length stem available in full profile and reduced distal options;
- Polished Anterior-Posterior Neck Flats increase ROM by geometrically reducing the potential for impingement of the neck with the cup;
- Flat Tapered Wedge Geometry Enhances proximal offloading and bone preservation and provides for rotational stability;
- Reduced Distal Transition Enhances implant fit in femoral canals with a proximal distal mismatch.



Tapered design provides maximum bone preservation

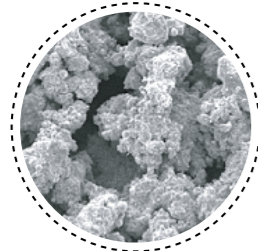

Proximal coating: Titanium Plasma Spray

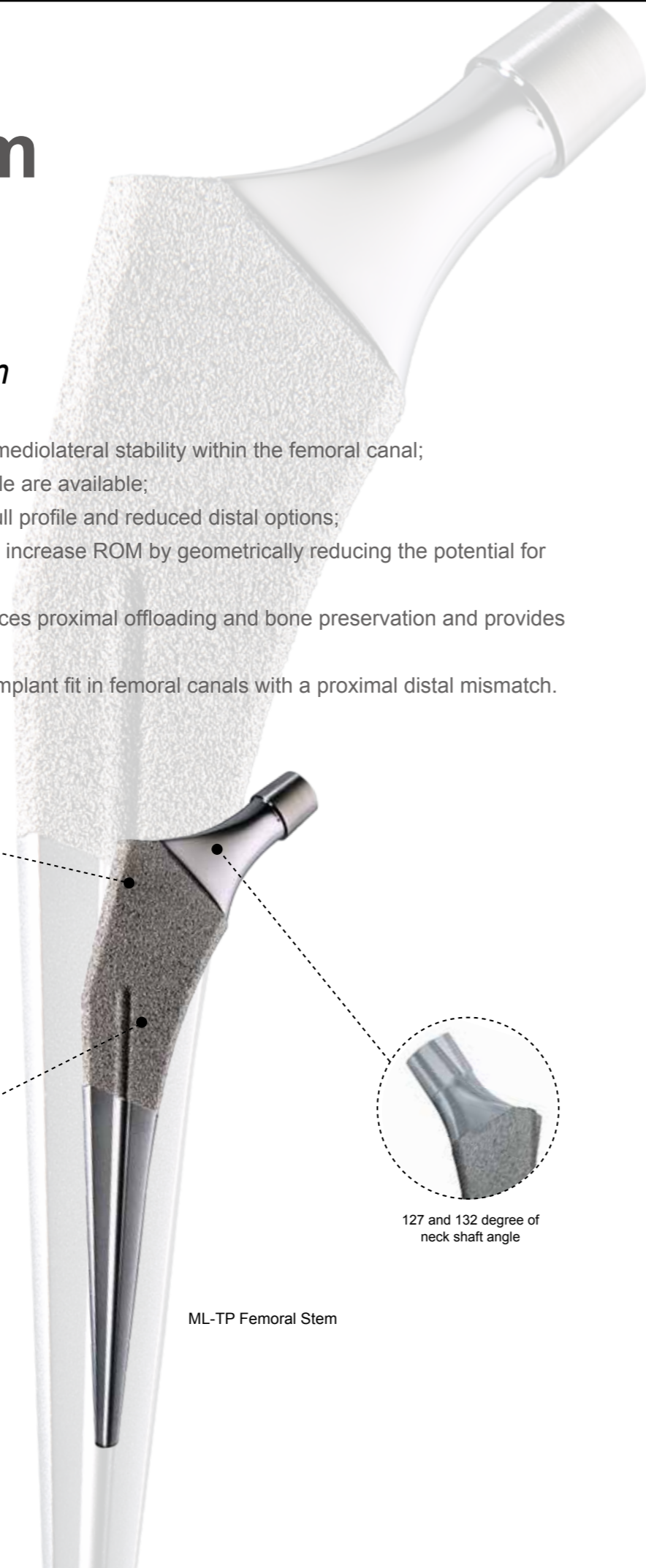

ML-TP Femoral Stem



127 and 132 degree of neck shaft angle

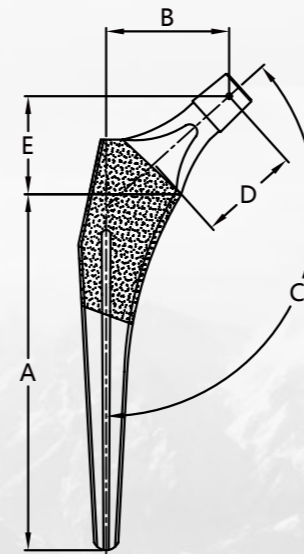

AK-ML-TP Femoral Stem (127°)

Size Ref.	Cat. No.	Description	Neck Shaft Angle (C)	Stem Length (A)	Offset (B)	Neck Length (D)	Neck Height (E)	Distal Dia.
1#	1100-3801	Name: AK-ML-TP Femoral Stem (127°) Material: Titanium Alloy Surface Coating: Ti. plasma spray Taper: 12/14	127°	110	39	31	27	5
2#	1100-3802			115	40	31	27	7.5
2.5#	1100-3825			118	41	31	27	9
3#	1100-3803			120	45	36	30	10
3.5#	1100-3835			124	46	36	30	11
4#	1100-3804			125	47	36	30	12.5
4.5#	1100-3845			129	48	36	30	13.5
5#	1100-3805			130	50	38	31	15
5.5#	1100-3855	133	50	38	31	16.5		
6#	1100-3806	135	51	38	31	17.5		
7#	1100-3807	140	54	41	33	20		
8#	1100-3808	145	56	41	33	22.5		

AK-ML-TP Femoral Stem (132°)

Size Ref.	Cat. No.	Description	Neck Shaft Angle (C)	Stem Length (A)	Offset (B)	Neck Length (D)	Neck Height (E)	Distal Dia.
1#	1100-2801	Name: AK-ML-TP Femoral Stem (132°) Regulatory Supplied Material: Titanium Alloy Surface Coating: Ti. plasma spray Taper: 12/14	132°	110	36	31	30	5
2#	1100-2802			115	37	31	30	7.5
2.5#	1100-2825			118	38	31	30	9
3#	1100-2803			120	42	36	33	10
3.5#	1100-2835			124	42	36	33	11
4#	1100-2804			125	43	36	34	12.5
4.5#	1100-2845			129	44	36	34	13.5
5#	1100-2805			130	45	38	35	15
5.5#	1100-2855	133	46	38	35	16.5		
6#	1100-2806	135	47	38	35	17.5		
7#	1100-2807	140	50	41	37	20		
8#	1100-2808	145	51	41	37	22.5		

AK-ML-TH Femoral Stem

- Proximal Coating: Titanium Plasma Spray + HA Coating;
- Tapered Wedge design provides firm mediolateral stability within the femoral canal;
- Both 127° and 132° of Neck Shaft Angle are available;
- 24 sizes full length stem available in full profile and reduced distal options;
- Polished Anterior-Posterior Neck Flats increase ROM by geometrically reducing the potential for impingement of the neck with the cup;
- Flat Tapered Wedge Geometry Enhances proximal offloading and bone preservation and provides for rotational stability;
- Reduced Distal Transition Enhances implant fit in femoral canals with a proximal distal mismatch.



Tapered design provides maximum bone preservation



127 and 132 degree of neck shaft angle

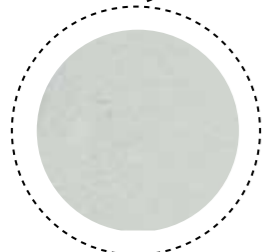

Proximal coating: Titanium Plasma Spray and Hydroxyapatite Coating

ML-TH Femoral Stem

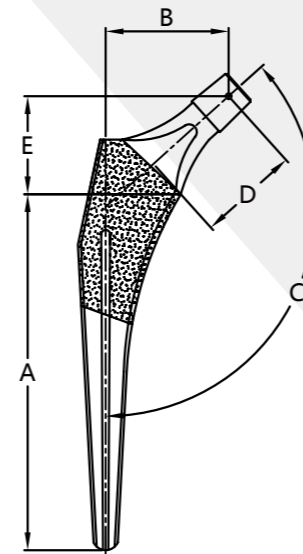

AK-ML-TH Femoral Stem(127°)

Size Ref.	Cat. No.	Description	Neck Shaft Angle (C)	Stem Length (A)	Offset (B)	Neck Length (D)	Neck Height (E)	Distal Dia.
1#	1100-3201	Name:AK-ML-TH Femoral Stem(127°) Material: Titanium Alloy Surface Coating: Ti+HA plasma spray Taper: 12/14	127°	110	39	31	27	5
2#	1100-3202			115	40	31	27	7.5
2.5#	1100-3225			118	41	31	27	9
3#	1100-3203			120	45	36	30	10
3.5#	1100-3235			124	46	36	30	11
4#	1100-3204			125	47	36	30	12.5
4.5#	1100-3245			129	48	36	30	13.5
5#	1100-3205			130	50	38	31	15
5.5#	1100-3255	133	50	38	31	16.5		
6#	1100-3206	135	51	38	31	17.5		
7#	1100-3207	140	54	41	33	20		
8#	1100-3208	145	56	41	33	22.5		

AK-ML-TH Femoral Stem(132°)

Size Ref.	Cat. No.	Description	Neck Shaft Angle (C)	Stem Length (A)	Offset (B)	Neck Length (D)	Neck Height (E)	Distal Dia.
1#	1100-3301	Name:AK-ML-TH Femoral Stem(132°) Material: Titanium Alloy Surface Coating: Ti+HA plasma spray Taper: 12/14	132°	110	36	31	30	5
2#	1100-3302			115	37	31	30	7.5
2.5#	1100-3325			118	38	31	30	9
3#	1100-3303			120	42	36	33	10
3.5#	1100-3335			124	42	36	33	11
4#	1100-3304			125	43	36	34	12.5
4.5#	1100-3345			129	44	36	34	13.5
5#	1100-3305			130	45	38	35	15
5.5#	1100-3355	133	46	38	35	16.5		
6#	1100-3306	135	47	38	35	17.5		
7#	1100-3307	140	50	41	37	20		
8#	1100-3308	145	51	41	37	22.5		

AK-MP-TP Femoral Stem

- MP stem is cementless designs developed following the classic tapered stem philosophy;
- Polished bullet-shape distal tip reduces distal stresses;
- MP stem is precision manufactured from high-strength forged titanium alloy and incorporate a 3-degree biplanar taper;
- Each stem has a medially rounded, laterally flared, proximal cross-sectional geometry that has been refined for optimal fit and fill and rotational stability.

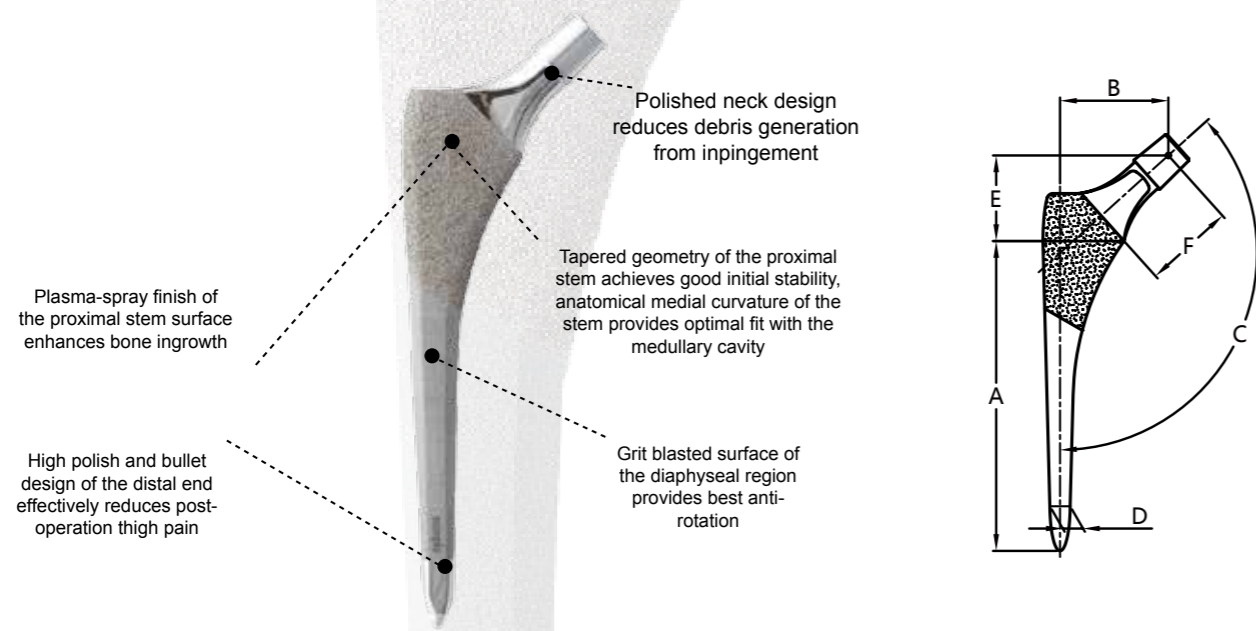

AK-MP-TP Femoral Stem(132°)

Size Ref.	Cat. No.	Description	Neck Shaft Angle (C)	Stem Length (A)	Offset (B)	Neck Length (F)	Neck Height (E)	Distal Dia. (D)
7#	1100-2007	Name:AK-MP-TP Femoral Stem(132°) Regularly Supplied Material: Titanium Alloy Surface Coating: Ti. plasma spray Taper: 12/14	132°	110	39	33	31	7
8#	1100-2008			115	39	33	31	8
9#	1100-2009			120	40	33	32	9
10#	1100-2020			130	40	33	32	10
11#	1100-2011			130	42	35	34	11
12#	1100-2012			140	44	37	35	12
13#	1100-2013			150	45	38	36	13
14#	1100-2014			150	45	39	37	14

AK-CL-TH Femoral Stem

- The CL stem gives primary mechanical stability with good optimum filling;
- Low-profile lateral shoulder design enables easy insertion in reduced incision techniques, especially the anterior approach;
- Double Coated stem with 50 µm pure titanium and 150 µm HA coating;
- CL hip system is manufactured from forged titanium alloy (Ti-6Al-4V) ensuring high fatigue resistance and biocompatibility;
- The double taper trapezoidal design resists axial and torsional displacement providing excellent stability;
- Metaphyseal flare ensures maximum fixation and load transfer into the proximal femur.

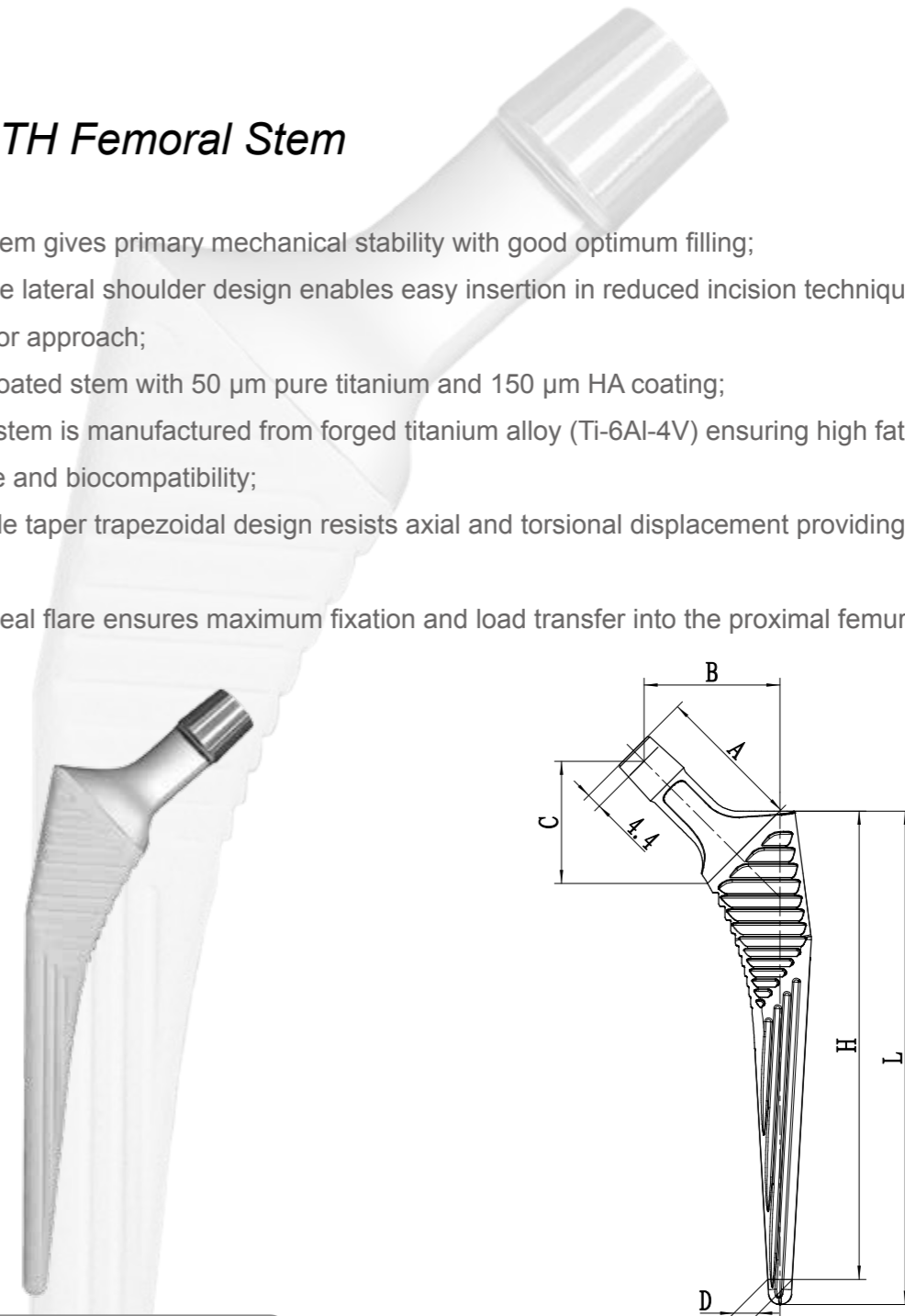

AK-CL-TH Femoral Stem(135°)

Size Ref.	Cat. No.	Description	Neck Shaft Angle	Neck Length (A)	Offset (B)	Neck Height (C)	Distal Dia. (D)	Stem Length (H)	Stem Length (L)
2#	1100-4202	Name:AK-CL-TH Femoral Stem(135°) Regularly Supplied Material: Titanium Alloy Surface Coating: HA plasma spray Taper: 12/14	135°	38	35.0	32.3	5.7	124	130
3#	1100-4203			41	38.1	34.5	6.6	134	140
4#	1100-4204			41	38.6	34.5	7.2	138	145
5#	1100-4205			41	39.6	34.5	8.6	143	150
6#	1100-4206			41	40.1	34.5	9.2	147	155
7#	1100-4207			41	40.6	34.5	9.5	153	160
8#	1100-4208			41	41.6	34.5	10.9	158	165
9#	1100-4209			41	42.1	34.5	11.5	162	170
10#	1100-4210			41	43.1	34.5	12.4	172	180
11#	1100-4211			41	44.1	34.5	13.4	181	190

AK-SL-Cone Femoral Stem

- Uncemented fixation based on the positive experience with the SL Revision Stem;
- CCD-angle of 125° and 135°;
- Conical shape with a cone angle of 5°;
- 8 Sharp longitudinal ribs;
- Free setting of antetorsion;
- Titanium alloy with a rough blasted surface (Protasul™-100);
- Stem Diameter from Φ 13 mm to Φ 23 mm;
- Designed for difficult bone conditions at the proximal end of the femur;
- Deformities of the femurs in which fixation of a standard prosthesis is difficult;
- Simple Revisions.

AK-SL-Cone Femoral Stem(125°)

Size Ref.	Cat. No.	Description	Neck Shaft Angle	Rib Height (E)	Distal Dia. (F)	Stem Dia. (D)	Offset (B)	Stem Length (C)
0#	1100-2900	Name:AK-SL-Cone Femoral Stem(125°) Regularly Supplied Material: Titanium Alloy Surface Coating: Grit-blasted Taper: 12/14	125°	1	6.2	13	28	115
1#	1100-2901			1	6.4	14	32	125
2#	1100-2902			1	7.4	15	33	125
3#	1100-2903			1.5	8.5	16	33	125
4#	1100-2904			1.5	9.5	17	34	125
5#	1100-2905			1.5	10.5	18	35	125
6#	1100-2906			2	11.6	19	36	125
7#	1100-2907			2	12.6	20	37	125
8#	1100-2908			2	13.7	21	38	125
9#	1100-2909			2	14.8	22	38	125
10#	1100-2910	2.5	15.8	23	39	125		

AK-SL-Cone Femoral Stem(135°)

Size Ref.	Cat. No.	Description	Neck Shaft Angle	Rib Height (E)	Distal Dia. (F)	Stem Dia. (D)	Offset (B)	Stem Length (C)
11#	1100-2911	Name:AK-SL-Cone Femoral Stem(135°) Regularly Supplied Material: Titanium Alloy Surface Coating: Grit-blasted Taper: 12/14	135°	1	6.2	13	26	115
12#	1100-2912			1	6.4	14	30	125
13#	1100-2913			1	7.4	15	30	125
14#	1100-2914			1.5	8.5	16	31	125
15#	1100-2915			1.5	9.5	17	32	125
16#	1100-2916			1.5	10.5	18	33	125
17#	1100-2917			2	11.6	19	33	125
18#	1100-2918			2	12.6	20	34	125
19#	1100-2919			2	13.7	21	35	125
20#	1100-2920			2	14.8	22	35	125
21#	1100-2921			2.5	15.8	23	36	125

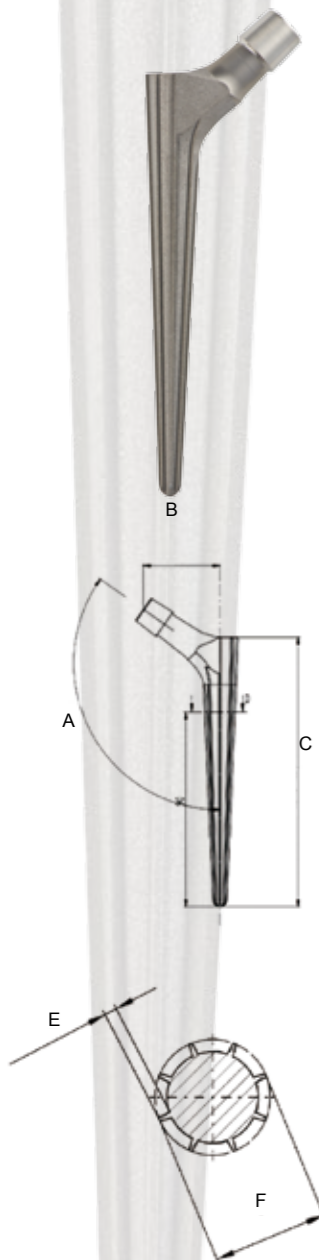

AK-SL Femoral Stem

- Guaranteed distal fixation in used of Wagner principle;
- AK-SL stem designed for uncemented fixation in femoral revision surgery. A 2° tapered stem with a circular cross-section, the AK-SL can be placed in any version by the surgeon;
- AK-SL stem has 8 longitudinal ribs with relatively sharp ridges that are intended to engage the femoral cortex, thus enabling optimum rotational stability;
- AK-SL Stem length along with the secure fit of the taper design and the torsionally resistant ribs provide firm fixation to the healthy bone distal to the original prosthetic bed.

AK-SL Femoral Stem

Size Ref.	Cat. No.	Description	Neck Shaft Angle (C)	Stem Length (A)	Offset (B)	Stem Dia. (E)	Neck Length (D)	Distal Dia. (F)	Rib Height (G)
23#	1100-2923	Name:AK-SL Femoral Stem Material: Titanium Alloy Regularly Supplied Surface Coating: Grit-blasted Taper: 12/14	135°	190	42	14	59	10.3	1
24#	1100-2924			190	42	15	59	11.3	1.2
25#	1100-2925			190	42	16	59	12.3	1.3
26#	1100-2926			190	42	17	59	13.3	1.5
27#	1100-2927			190	44	18	62	14.4	1.6
28#	1100-2928			190	44	19	62	15.4	2
29#	1100-2929			190	44	20	62	16.4	2
32#	1100-2932			225	42	14	59	10.3	1
33#	1100-2933			225	42	15	59	11.3	1.2
34#	1100-2934			225	42	16	59	12.3	1.3
35#	1100-2935			225	42	17	59	13.3	1.5
36#	1100-2936			225	44	18	62	14.4	1.6
37#	1100-2937			225	44	19	62	15.4	2
38#	1100-2938			225	44	20	62	16.4	2
39#	1100-2939			225	44	21	62	17.4	2
40#	1100-2940			225	46	22	65	18.4	2

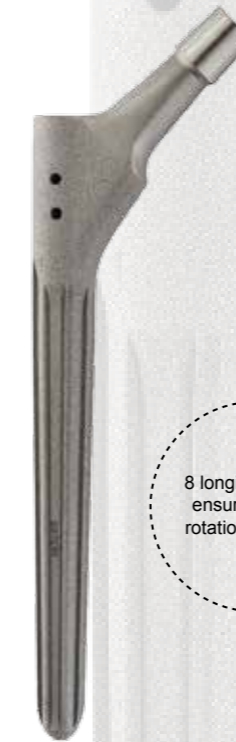

8 longitudinal ribs ensure the anti-rotational stability

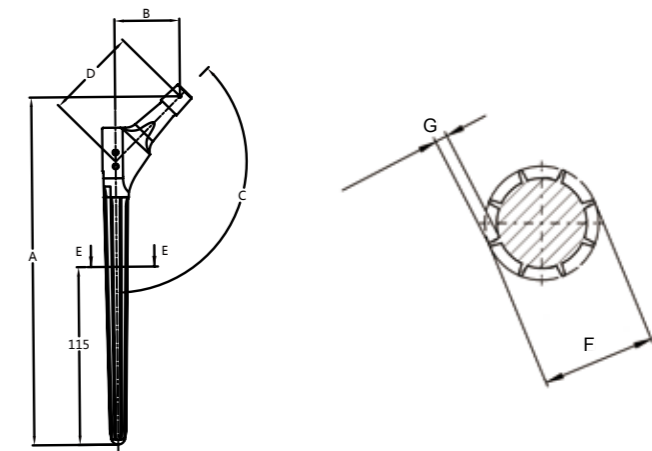

AK-MR Femoral Stem

- AK-MR Stem provides the opportunity to treat wide variances in patient anatomy, and allowing extensive fixation in the femur, this design philosophy in femoral revision surgery has been impressive. These results show the favorable remodeling of proximal femoral bone stock when excessive bone loss was present;
- AK-MR Stem were designed to achieve secure distal fixation in the femur using a sharply splined and tapered distal stem;
- The tapered distal stem is designed to wedge into the femoral medullary canal, transferring axial and bending forces, while the splines are press-fit into the bone to provide rotational stability;
- A bevel at the distal end of the stem is a design feature intended to increase the ease of insertion, to better accommodate the bow of the femur, and decrease the potential for distal femoral cortical perforation;
- Multiple sizes in each body type allow for metaphyseal filling, proximal fixation, and proximal support of the prosthesis.

AK-MR Proximal Femoral Stem

Size Ref.	Cat. No.	Description	Neck Shaft Angle (C)	Proximal Stem Length (A)	Offset(B)
1#	1100-2501	Name:AK-MR Proximal Femoral Stem Regularly Supplied Material: Titanium Alloy Surface: Grit-blasted Taper: 12/14	132°	50	40
2#	1100-2502			60	40
3#	1100-2503			70	40
4#	1100-2504			80	40
5#	1100-2505			90	40
6#	1100-2506			100	40
7#	1100-2507			110	40

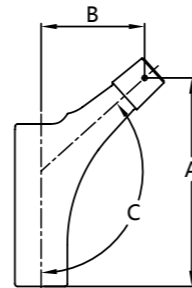

AK-MR Distal Femoral Stem

Size Ref.	Cat. No.	Description	ECC Angle	Stem Dia. (D)	Distal Stem Length (L)
Φ14×165	1300-1414	Name:AK-MR Distal Femoral Stem Regularly Supplied Material: Titanium Alloy Surface: Grit-blasted Taper: 12/14	4°	14	132
Φ14×225L	1300-1420L			14	192
Φ15×165	1300-1514			15	132
Φ15×225L	1300-1520L			15	192
Φ16×165	1300-1614			16	132
Φ16×225L	1300-1620L			16	192
Φ17×165	1300-1714			17	132
Φ17×225L	1300-1720L			17	192
Φ18×165	1300-1814			18	132
Φ18×225L	1300-1820L			18	192
Φ19×165	1300-1914			19	132
Φ19×225L	1300-1920L			19	192
Φ20×165	1300-2014			20	132
Φ20×225L	1300-2020L			20	192
Φ22×165	1300-2214	22	132		
Φ22×225L	1300-2220L	22	192		

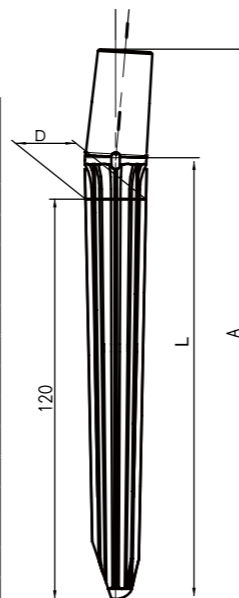

8 longitudinal ribs ensure the anti-rotational stability

AK-ABM Femoral Stem

AK-ABM Proximal Femoral Stem

Size Ref.	Description	Diameter (A)	Proximal Stem Length (H)
1#	Name: AK-ABM Proximal Femoral Stem Regularly Supplied Material: Titanium Alloy Taper: 12/14	19	60
2#			70
3#			80
4#			90
5#			100
6#		21	60
7#			70
8#			80
9#			90
10#			100
11#		23	60
12#			70
13#			80
14#			90
15#			100
16#		25	60
17#			70
18#			80
19#			90
20#			100

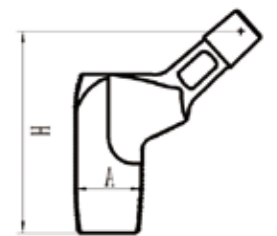

AK-ABM Distal Femoral Stem

Size Ref.	Description	Diameter(A)	Proximal Stem Length (L)
1#	Name: AK-ABM Proximal Femoral Stem Regularly Supplied Material: Titanium Alloy Taper: 12/14	14	135
2#		15	135
3#		16	135
4#		17	135
5#		18	135
6#		19	135
7#		14	195
8#		15	195
9#		16	195
10#		17	195
11#		18	195
12#		19	195

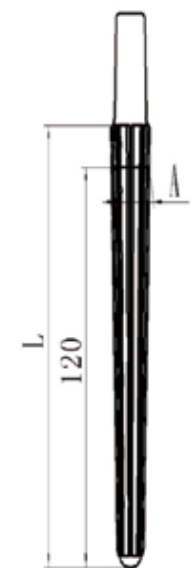

AK-SR Femoral Stem

- AK-SR is modular and therefore very versatile, it provides a single system approach to Primary THR, Complex primary (DDH), Revision, Tumours;
- Coronal slot design reduces distal stiffness of stem and reduces effect of modulus mismatch, the design also reduces incidence of thigh pain /fracture;
- Calcar replacement allows treatment of bone loss to below the level of the lesser trochantery;
- AK-SR Stem length along with the secure fit of the taper design and the torsionally resistant ribs provide firm fixation to the healthy bone distal to the original prosthetic bed.

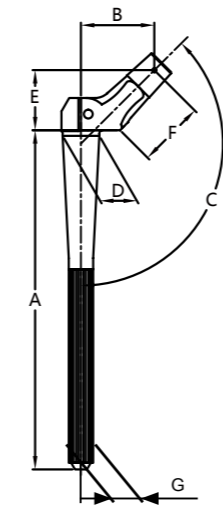
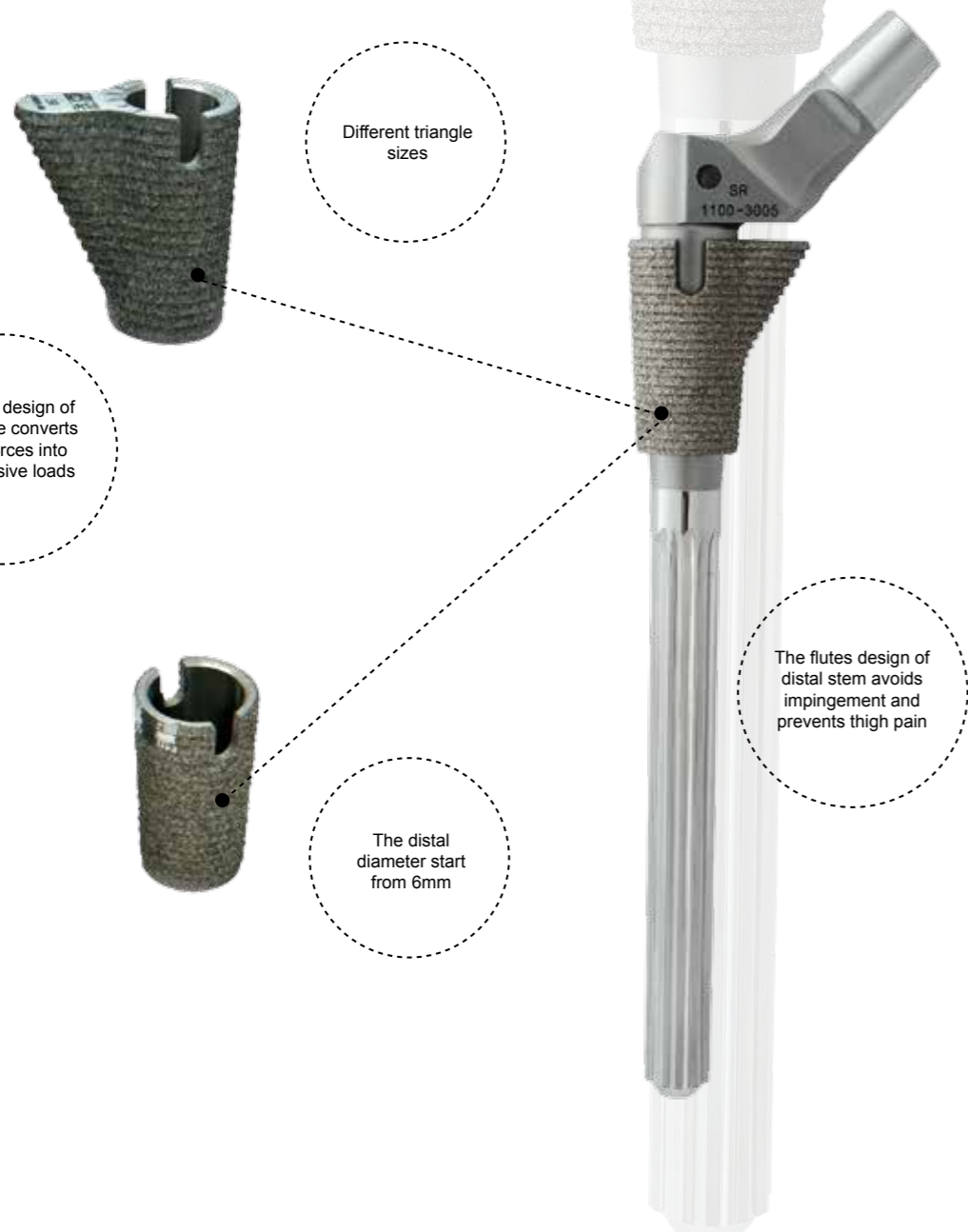

AK-SR Femoral Stem

Size Ref.	Cat. No.	Description	Neck Shaft Angle (C)	Stem Length (A)	Proximal Dia. (D)	Offset (B)	Neck Height (E) x Length (F)	Distal Dia. (G)
0#	1100-3000	Name:AK-SR Femoral Stem Material: Titanium Alloy Regularly Supplied Surface:Grit-blasted Taper: 12/14	135°	117.5	12	33	27 x 30	6
1#	1100-3001			117.5	12	33	27 x 30	7
2#	1100-3002			132.5	14	33	27 x 30	8
3#	1100-3003			132.5	14	33	27 x 30	9
4#	1100-3004			152.5	16	33	27 x 30	10
5#	1100-3005			152.5	16	33	27 x 30	11
6#	1100-3006			162.5	18	33	27 x 30	12
7#	1100-3007			162.5	18	33	27 x 30	13
8#	1100-3008			167.5	20	33	27 x 30	14
9#	1100-3009			167.5	20	33	27 x 30	15
10#	1100-3010			162.5	18	37	31 x 36	12
11#	1100-3011			162.5	18	37	31 x 36	13
12#	1100-3012			167.5	20	37	31 x 36	14
13#	1100-3013			167.5	20	37	31 x 36	15
14#	1100-3014			167.5	22	37	31 x 36	16
15#	1100-3015	167.5	22	37	31 x 36	17		

The size of AK-SR Femoral Stem's Proximal Diameter (D) is matched with the AK-SR Femoral Stem Sleeve's Size Reference.

AK-SR Proximal Sleeve

Cat. No.	Description	Size Ref.	Spout (A)	Thickness (B)	Inner Dia. (D)
1301-12A	Name: AK-SR Proximal Sleeve Material: Titanium Alloy Regularly Supplied Surface: Titanium Spray Taper: 12/14	Φ12A	—	1.5	12
1301-12SB		Φ12SB	9.5	1.5	12
1301-12LB		Φ12LB	13.5	1.5	12
1301-12SD		Φ12SD	9.5	2.5	12
1301-12LD		Φ12LD	13.5	2.5	12
1301-14A		Φ14A	—	1.5	14
1301-14SB		Φ14SB	9.5	1.5	14
1301-14LB		Φ14LB	13.5	1.5	14
1301-14SD		Φ14SD	9.5	2.5	14
1301-14LD		Φ14LD	13.5	2.5	14
1301-16A		Φ16A	—	1.5	16
1301-16SB		Φ16SB	9.5	1.5	16
1301-16LB		Φ16LB	13.5	1.5	16
1301-16SD		Φ16SD	9.5	2.5	16
1301-16LD		Φ16LD	13.5	2.5	16
1301-18SB		Φ18SB	9.5	1.5	18
1301-18LB		Φ18LB	13.5	1.5	18
1301-18SD		Φ18SD	9.5	2.5	18
1301-18LD		Φ18LD	13.5	2.5	18
1301-20SB		Φ20SB	9.5	1.5	20
1301-20LB		Φ20LB	13.5	1.5	20
1301-20SD		Φ20SD	9.5	2.5	20
1301-20LD	Φ20LD	13.5	2.5	20	
1301-22SB	Φ22SB	9.5	1.5	22	
1301-22LB	Φ22LB	13.5	1.5	22	
1301-22SD	Φ22SD	9.5	2.5	22	
1301-22LD	Φ22LD	13.5	2.5	22	

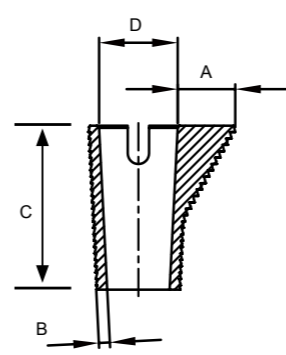

CPII Cemented Femoral Stem

- Double tapered stem design helps to create radial compressive loading ;
- Additional stability and support for distal femoral defects;
- Increasing compression and reducing shear at the bone/cement and implant/cement interfaces;
- Polished surface helps to reduce friction between the cement and the implant reducing potential for third body wear;
- Collarless neck helps to facilitate adjustments, allow intraoperative leg length adjustment aided by reference points on both the stem and the rasp.

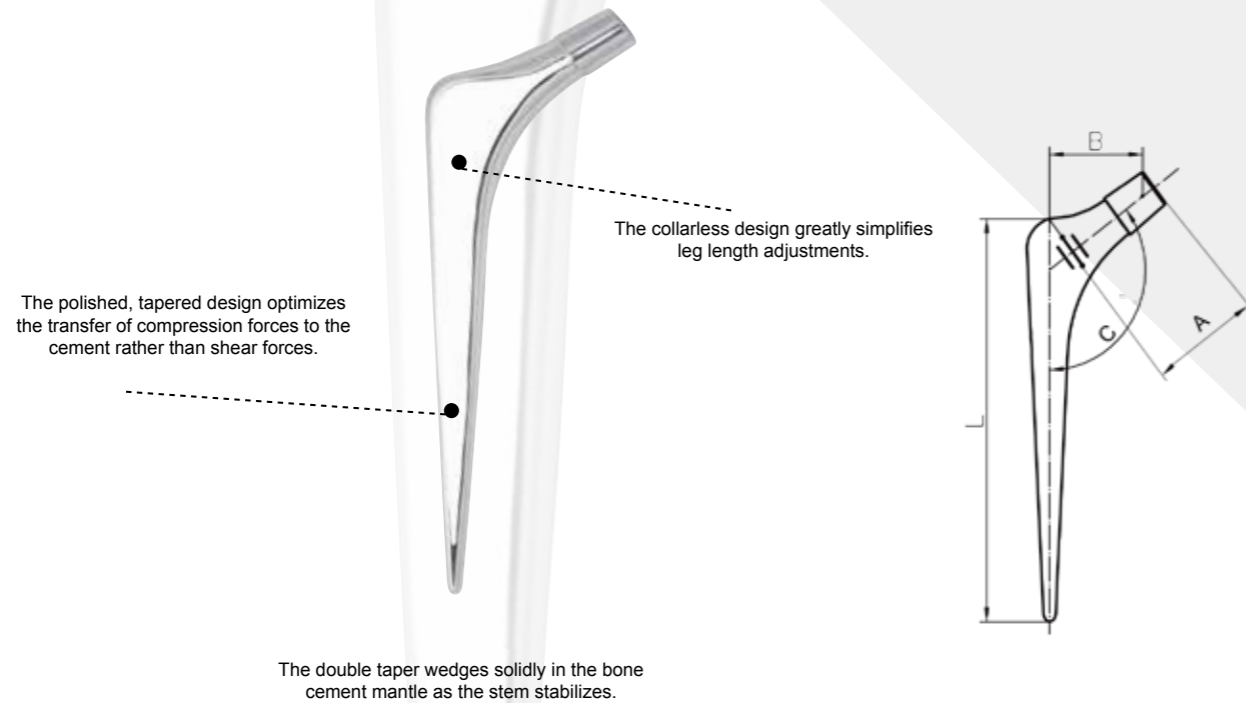

CPII Cemented Femoral Stem

Size Ref.	Cat. No.	Description	Neck Shaft Angle (C)	Stem Length (L)	Offset (B)	Neck Length (A)	Distal Dia.
00#	2100-1100	Name:CPII Cemented Femoral Stem Customized Supplied Material: High Nitrogen Stainless Steel Surface: High Polished Taper: 12/14	127°	115	30	42	5
0#	2100-1000			133	33	45	5
1#	2100-1001			149	35.5	49	5
2#	2100-1002			170	37.5	51	5
3#	2100-1003			170	37.5	51	5
4#	2100-1004			170	37.5	51	5
5#	2100-1005			170	37.5	51	5
6#	2100-1006			171	37.5	51	5
7#	2100-1007			168	40	54	5
8#	2100-1008			168	40	54	5
9#	2100-1009			168	40	54	5
10#	2100-1010	168	40	54	5		
11#	2100-1011	169	40	54	5		

ACP and ACP Long Cemented Femoral Stems

- Double-taper design philosophy provides natural compressive forces to help ensure that the implant is firmly seated and wedged within the cement mantle;
- Polished surface designed to work in conjunction with taper geometry to enhance stem stability;
- Polished, tapered design intended to stabilize through controlled subsidence in the first 12 to 24 months.

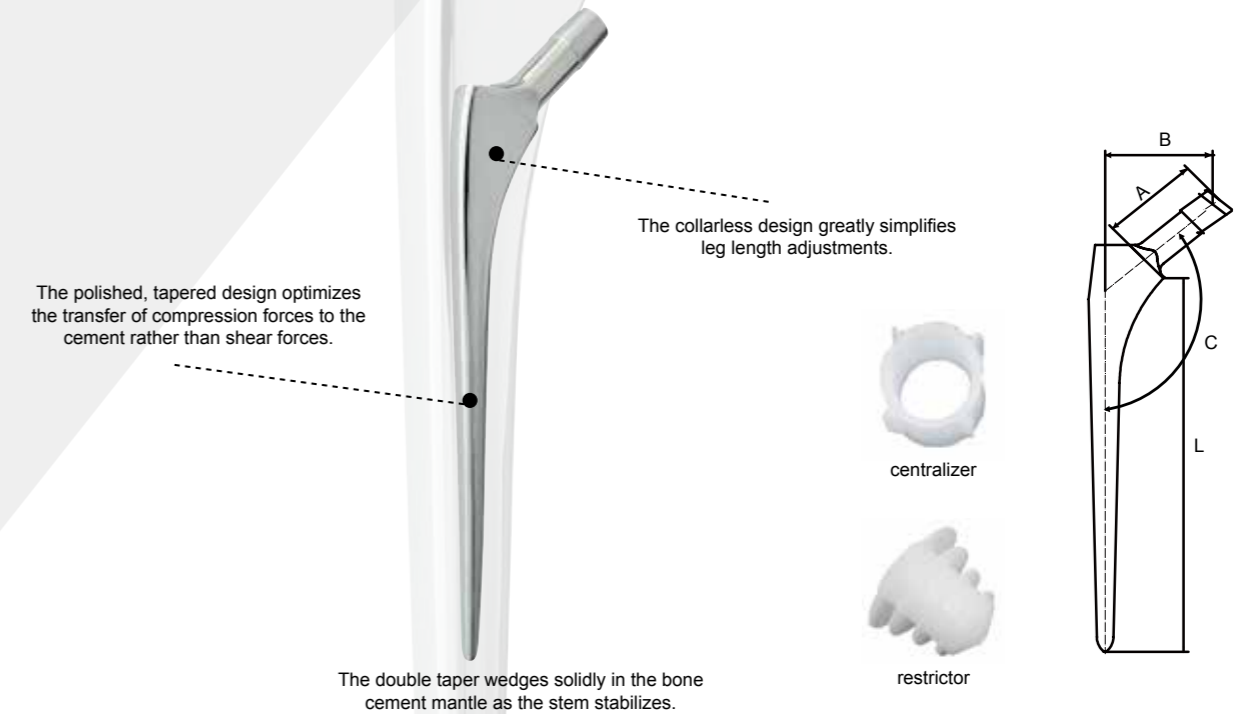

ACP Cemented Femoral Stem

Size Ref.	Cat. No.	Description	Neck Shaft Angle (C)	Stem Length L(mm)	Offset (B)	Neck Length (A)	Distal Dia.
00#	1100-1100	Name: ACP Cemented Femoral Stem	132°	105	32.5	32	5
0#	1100-1000	Regulary Supplied		110	37	37	5
1#	1100-1001	Material: Co-Cr-Mo		115	37	37	5.5
2#	1100-1002	Surface: High Polished		115	39	37	6
3#	1100-1003	Taper: 12/14		120	42	39	6

ACP Long Cemented Femoral Stem

Size Ref.	Cat. No.	Description	Neck Shaft Angle (C)	Stem Length L(mm)	Offset (B)	Neck Length (A)	Distal Dia.
4#(M)	1100-1004	Name: ACP Long Cemented Femoral Stem	132°	170	44	41	5
5#(L)	1100-1005	Regulary Supplied		200	45	42	5
14#(XS)	1100-1014	Material: Co-Cr-Mo		150	37.5	37	5
15#(S)	1100-1015	Surface: High Polished		160	38	37	5
		Taper: 12/14					

AK-THS Tumor Femoral Stem

- Each component is made of high standard titanium alloy which is closer to the elastic modulus of bone, and has excellent biocompatibility;
- The components are firmly locked by cone design;
- The proximal plexus and the small trochanter position reserve the tendon suture hole, which may restore muscle function;
- The proximal prosthetic surface is a vacuum plasma pure titanium coating, which facilitates long-term soft tissue adhesion;
- The extension stem has multiple specifications and can be freely assembled during surgery to provide physicians with more options for precise bone engagement.

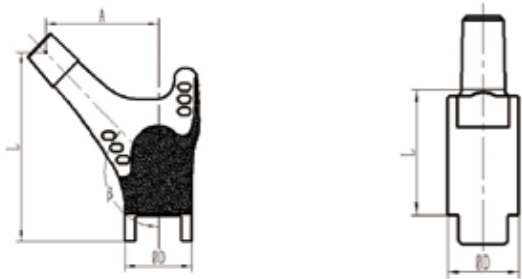

AK-THS Proximal Femoral Stem

Size Ref.	Cat. No.	Description	Neck Shaft Angle (β)	Proximal Stem Length (L)	Offset (A)	Stem Dia (D)
BG-XI-11#	1100-3111	Name: AK-THS Tumor Femoral Stem Type I Regularly Supplied Material: Titanium Alloy Taper: 12/14	135°	70	44	26

AK-THS Distal Femoral Stem - Type I

Size Ref.	Cat. No.	Description	Proximal Stem Length (L)	Stem Dia (D)
30mm	8700-1030	Name: AK-THS Tumor Femoral Stem Type I Regularly Supplied Material: Titanium Alloy Taper: 12/14	30	26
40mm	8700-1040		40	26
50mm	8700-1050		50	26
60mm	8700-1060		60	26
70mm	8700-1070		70	26
80mm	8700-1080		80	26
90mm	8700-1090		90	26
100mm	8700-1100		100	26



AK-THS Distal Femoral Stem - Type II

Size Ref.	Cat. No.	Description	Proximal Stem Length (L1)	Proximal Stem Length (L2)	Stem Dia (C)	Stem Dia (D)
Ø9×102	8701-0910	Name: AK-THS Tumor Femoral Stem Type II Regularly Supplied Material: Titanium Alloy Taper: 12/14	40	102	9	22
Ø11×127	8701-1112		40	127	11	24
Ø13×127	8701-1312		40	127	13	28
Ø15×127	8701-1512		40	127	15	32
Ø17×127	8701-1712		40	127	17	36

AK-THS Distal Femoral Stem - Type III

Size Ref.	Cat. No.	Description	Proximal Stem Length (L)	Stem Dia (D)
4#Ø9/102/10	8702-0911	Name: AK-THS Tumor Femoral Stem Type III Regularly Supplied Material: Co-Cr-Mo Taper: 12/14	9	102
7#Ø11/102/10	8702-1111		11	102
10#Ø11/127/10	8702-1121		11	127
13#Ø13/127/10	8702-1321		13	127
16#Ø15/127/10	8702-1521		15	127
19#Ø17/127/10	8702-1721		17	127

Centralizer

Size Ref.	Cat. No.	Description
Ø13	8664-1301	Name: Centralizer Material: UHMWPE
Ø15	8664-1501	
Ø17	8664-1701	

Restrictor

Size Ref.	Cat. No.	Description
Ø13.5	8606-1410	Name: Restrictor Material: UHMWPE
Ø17.5	8606-1810	

Acetabular System

AK-AC-I-TP Acetabular Cup with Liner

- Forged Titanium Alloy Cup and UHMWPE Liner;
- Titanium-Plasma Spray porous coating;
- Taper-lock mechanism ensures durable fixation;
- High edge liner design effectively prevents dislocation;
- 3 holes allows immediate screw fixation.

Three holes design ensures immediate fixation

10-degree high wall design prevents dislocation during motion.

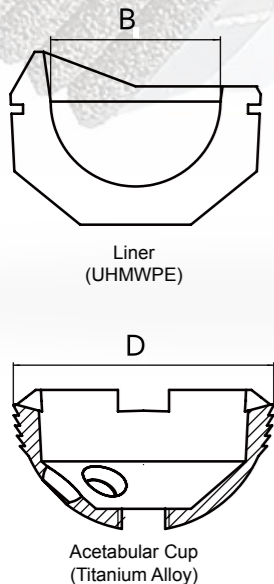

AK-AC-I-TP Acetabular Cup with Liner

Size Ref.	Cat. No.	Description	Cup Diameter (D)	Matched Femoral Head
42/22	1300-2242	Name:AK-AC-I-TP Acetabular Cup with Liner Material:Titanium Alloy+UHMWPE Liner Regulary Supplied Surface Coating: Titanium Plasma Spray Porous Coating Matched Stem: AK-ML-TP, AK-ML-TH, AK-MP-TP,AK-MF, AK-MR, AK-SL, AK-SR	43	22
44/22	1300-2244		45	22
46/22	1300-2246		47	22
48/28	1300-2848		49	28
50/28	1300-2850		51	28
52/28	1300-2852		53	28
54/28	1300-2854		55	28
56/28	1300-2856		57	28
58/28	1300-2858		59	28
60/28	1300-2860		61	28
62/28	1300-2862		63	28
52/32	1300-52DZ		53	32
54/32	1300-54DZ		55	32
56/32	1300-56DZ		57	32
58/32	1300-58DZ	59	32	
60/32	1300-60DZ	61	32	
62/32	1300-62DZ	63	32	

AK-AC-II-TP Acetabular Cup

- AK-AC-II-TP system is a two pieces component design that is assembled during surgery;
- The shells utilize the innerchange locking mechanism. This unique locking mechanism helps provide a secure interface between the polyethylene insert and shell;
- The shell is also suitable for both HXLPE and Ceramic Liner.

High porous coating support better biologic ingrowth

Liner ring serration design provides stable fixation between shell and liner and minimizes micromotion

AK-AC-II-TP Acetabular Cup

Size Ref. (O.D./Head Dia.)	Cat. No.	Description	Matched Liner size (O.D./I.D.)	Matched Liner size (O.D./I.D.)	Matched Liner size (O.D./I.D.)	Matched Femoral Head Diameter
38/22	1310-2238	Name: AK-AC-II-TP Acetabular Cup Material: Titanium Alloy Regulary Supplied Surface Coating: Titanium Plasma Spray Porous Coating from UK Matched Liner: AK-L-II Liner UHMWPE Matched Stem: AK-ML-TP, AK-ML-TH, AK-MP-TP, AK-MR, AK-SL, AK-MF, AP-SR	32/22	-	-	22
40/22	1310-2240		32/22	-	-	22
42/22	1310-2242		34/22	-	-	22
44/22	1310-2244		36/22	-	-	22
46/28	1310-2846		38/28	-	-	28
48/28	1310-2848		40/28	-	-	28
50/32	1310-3250		-	42/32	-	32
52/32	1310-3252		-	44/32	-	32
54/32	1310-3254		-	46/32	46/36	32/36
56/32	1310-3256		-	48/32	48/36	32/36
58/32	1310-3258		-	50/32	50/36	32/36
60/32	1310-3260		-	52/32	52/36	32/36
62/32	1310-3262		-	54/32	54/36	32/36
64/32	1310-3264		-	54/32	54/36	32/36

AK-L-II-Liner

- Both highly cross-linked Polyethylene and UHMWPE are available;
- The liners are designed to lock into the shell by means of a circumferential ring that engages the shell's mating groove;
- Rotational stability may be achieved when the shell's anti-rotational barbs interlock with the insert's scallops.

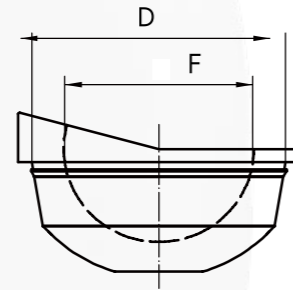

AK-L-II-Liner UHMWPE

Size Ref.	Cat. No.	Description	Matched Cup's Outer Dia.	Matched Femoral Head
38/22	1310-2338	Name: AK-L-II-Liner UHMWPE Material: UHMWPE(Ultrahigh molecular weight polyethylene) Regulary Supplied	38	22
40/22	1310-2340		40	22
42/22	1310-2342		42	22
44/22	1310-2344		44	22
46/28	1310-2346		46	28
48/28	1310-2348		48	28
50/32	1310-2450		50	32
52/32	1310-2452		52	32
54/32	1310-2454		54	32
56/32	1310-2456		56	32
58/32	1310-2458	58	32	
60/32	1310-2460	Mached Cup: AK-AC-II-TP AK-AC-II-TTM-I AK-AC-II-TTM-V	60	32
62/32	1310-2462		62	32
64/32	1310-2464		64	32

AK-L-II-Liner HXLPE

Size Ref.	Cat. No.	Description	Matched Cup's Inner Dia.	Matched Femoral Head
32/22	2329-3222	Name: AK-L-II-Liner HXLPE Material: HXLPE (High Cross Linked Polyethylene) Customzied Supplied	32	22
34/22	2329-3422		34	22
36/28	2329-3628		36	28
38/28	2329-3828		38	28
40/28	2329-4028		40	28
42/28	2329-4228		42	28
44/28	2329-4428		44	28
46/28	2329-4628		46	28
48/28	2329-4828		48	28
50/28	2329-5028		50	28
52/28	2329-5228		52	28
54/28	2329-5428		54	28
42/32	2329-4232		42	32
44/32	2329-4432		44	32
46/32	2329-4632		46	32
48/32	2329-4832		48	32
50/32	2329-5032		50	32
52/32	2329-5232		52	32
54/32	2329-5432		54	32
58/32	2329-5832		58	32
60/32	2329-6032	60	32	
46/36	2329-4636	46	36	
48/36	2329-4836	48	36	
50/36	2329-5036	50	36	
52/36	2329-5236	52	36	
54/36	2329-5436	54	36	
58/36	2329-5836	58	36	
60/36	2329-6036	60	36	

CP II Acetabular Cup

- UHMWPE;
- Monoblock cutting;
- 10 degree high wall design prevents dislocation during motion.

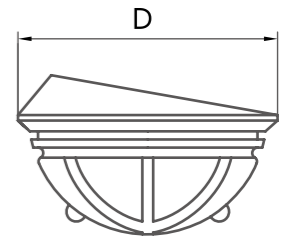

10-degree high wall design prevents dislocation during motion

AK CP II Acetabular Cup

Size Ref.	Cat. No.	Description	Cup Diameter (D)	Matched Femoral Head Dia.
38/22	2300-1038	Name: AK CP II Acetabular Cup Material: UHMWPE(Ultrahigh molecular weight polyethylene) Regulary Supplied	36	22
40/22	2300-1040		38	22
42/22	2300-1042		40	22
44/28	2300-1044		42	28
46/28	2300-1046		44	28
48/28	2300-1048		46	28
50/28	2300-1050		48	28
52/28	2300-1052		50	28
54/28	2300-1054		52	28
56/28	2300-1056		54	28
58/28	2300-1058		56	28
60/28	2300-1060		58	28
62/28	2300-1062	60	28	

CP Acetabular Cup

- UHMWPE;
- Monoblock cutting;
- 10 degree high wall design prevents dislocation during motion.



AK-CP Acetabular Cup

Size Ref.	Cat. No.	Description	Cup Diameter	Matched Femoral Head Dia.
44/28	1300-1044	Name: AK-CP Acetabular Cup Material: UHMWPE(Ultrahigh molecular weight polyethylene) Regulary Supplied	44	28
46/28	1300-1046		46	28
48/28	1300-1048		48	28
50/28	1300-1050		50	28
52/28	1300-1052		52	28
54/28	1300-1054		54	28
56/28	1300-1056		56	28
58/28	1300-1058		58	28

AK-C-Liner Ceramic

AK-C-Liner Ceramic



Size Ref.	Cat. No.	Description	Matched Cup's Inner Dia.	Matched Femoral Head
28/36	A2400-2836	Name: AK-C-Liner Ceramic Material: Ceramic Delta Customized Supplied Matched Cup: AK-AC-II-TP AK-AC-II-TTM-I AK-AC-II-TTM-V	36	28
28/38	A2400-2838		38	28
32/40	A2400-3240		40	32
32/42	A2400-3242		42	32
36/44	A2400-3644		44	36
36/46	A2400-3646		46	36
36/48	A2400-3648		48	36
36/50	A2400-3650		50	36
36/52	A2400-3652		52	36
36/54	A2400-3654		54	36

AK-FH-C Femoral Head

AK-FH-C Femoral Head

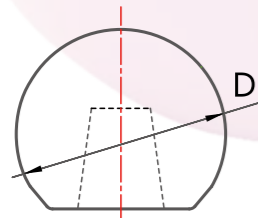

Size Ref.	Cat. No.	Description	Dia.	Trade Mark
28-S	2202-0028	Name: AK-FH-C Femoral Head Material: Ceramic Delta Customized Supplied Matched Stem: AK-ML-TP, AK-ML-TH, AK-MP-TP, AK-MF, AK-MR, AK-SR, AK-SL, AK-CL, AK-SL-CONE	28	BIOLOX from CeramTec
28-M	2202-0128		28	
28-L	2202-0228		28	
32-S	2202-0032		32	
32-M	2202-0132		32	
32-L	2202-0232		32	
32-XL	2202-0332		32	
36-S	2202-0036		36	
36-M	2202-0136		36	
36-L	2202-0236		36	
36-XL	2202-0336	36		

AK-Bipolar

- Co-Cr-Mo Alloy Cup and UHMWPE Liner;
- Patent locking mechanism ensures easy femoral head installation and prevents dislocation.

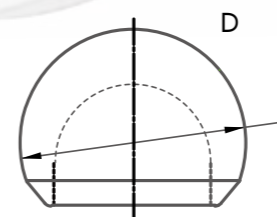

AK-Bipolar

Size Ref.	Cat. No.	Description	Outer Dia.	Matched Femoral Head
38/22	1220-3822	Name: AK-Bipolar Material: Co-Cr-Mo Alloy Cup+UHMWPE Liner Regularly Supplied Matched Head: For All 22 and 28	38	22
40/22	1220-4022		40	22
41/22	A2361-4122(1)		41	22
42/22	1220-4222		42	22
43/22	A2361-4322(1)		43	22
44/22	1220-4422		44	22
42/28	A2361-4228(1)		42	28
43/28	A2361-4328(1)		43	28
44/28	A2361-4428(1)		44	28
45/28	A2361-4528(1)		45	28
46/28	1220-4628		46	28
47/28	A2361-4728(1)		47	28
48/28	1220-4828		48	28
49/28	A2361-4928(1)		49	28
50/28	1220-5028		50	28
51/28	A2361-5128(1)		51	28
52/28	1220-5228	52	28	
53/28	A2361-5328(1)	53	28	
54/28	1220-5428	54	28	
56/28	1220-5628	56	28	

AK-FH-M Femoral Head

- Co-Cr-Mo Alloy material;
- 22mm, 28mm, 32mm, 36mm diameter options;
- Different neck lengths are available.

AK-FH-M Femoral Head

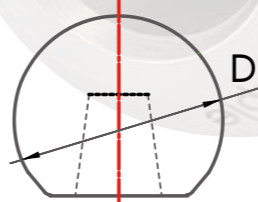
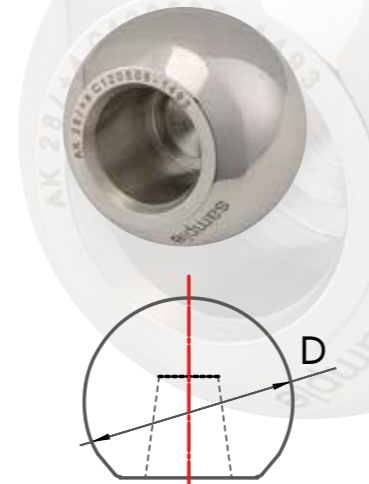

Size Ref.	Cat. No.	Description	Dia.	Matched Head Trial
22/0	1200-0122	Name: AK-FH-M Femoral Head Material: Co-Cr-Mo Alloy Regularly Supplied for Size Below 32 Matched Stem: AK-ML-TP, AK-ML-TH, AK-MP-TP, AK-MF, AK-MR, AK-SL, AK-SR, ACP, ACP Long	22	22/0
22/+4	1200-0222		22	22/+4
22/+8	1200-0322		22	22/+8
28/-4	1200-0028		28	28/-4
28/0	1200-0128		28	28/0
28/+4	1200-0228		28	28/+4
28/+8	1200-0328		28	28/+8
32/-4	1200-0032		32	32/-4
32/0	1200-0132		32	32/0
32/+4	1200-0232		32	32/+4
32/+8	1200-0332		32	32/+8
36/-4	1200-0036		36	36/-4
36/0	1200-0136		36	36/0
36/+4	1200-0236		36	36/+4

Acetabular Cup Screw

- It is made of Ti-Alloy;
- Various sizes for different needs.



Acetabular Cup Screw

Size Ref.	Cat. No.	Description	Length (mm)	Dia.
15mm	1300-2015	Name: Acetabular Cup Screw Material: Titanium Alloy	15	6.5
20mm	1300-2020		20	6.5
25mm	1300-2025		25	6.5
30mm	1300-2030		30	6.5
35mm	1300-2035		35	6.5
40mm	1300-2040		40	6.5
45mm	1300-2045		45	6.5
50mm	1300-2050		50	6.5
55mm	1300-2055		55	6.5
60mm	1300-2060		60	6.5
65mm	1300-2065		65	6.5
70mm	1300-2070		70	6.5

Acetabular Cage

- Pure titanium is extremely pliable, making it easy to use. The rough-blasted bone-facing surface offers excellent compatibility and enhances bone ongrowth;
- The relative position and orientation of the flanges match the anatomy of the pelvis, so the flanges require less time-consuming adaptation;
- The optimized position and orientation of the screw holes bring the screws in line with the direction of the force applied for secure initial, and long-term, stability. The large number of screw holes allows the surgeon to choose the most reliable fixation option;
- Inferior narrowing of the cage's posterior rim means that intact bone of the posterior acetabular rim can be preserved;
- The slim, pointed, upwardly curved inferior flange is designed specially for the modern technique of impacting the implant into the os ischium. Its lower placement offers optimal positioning of the center of rotation.

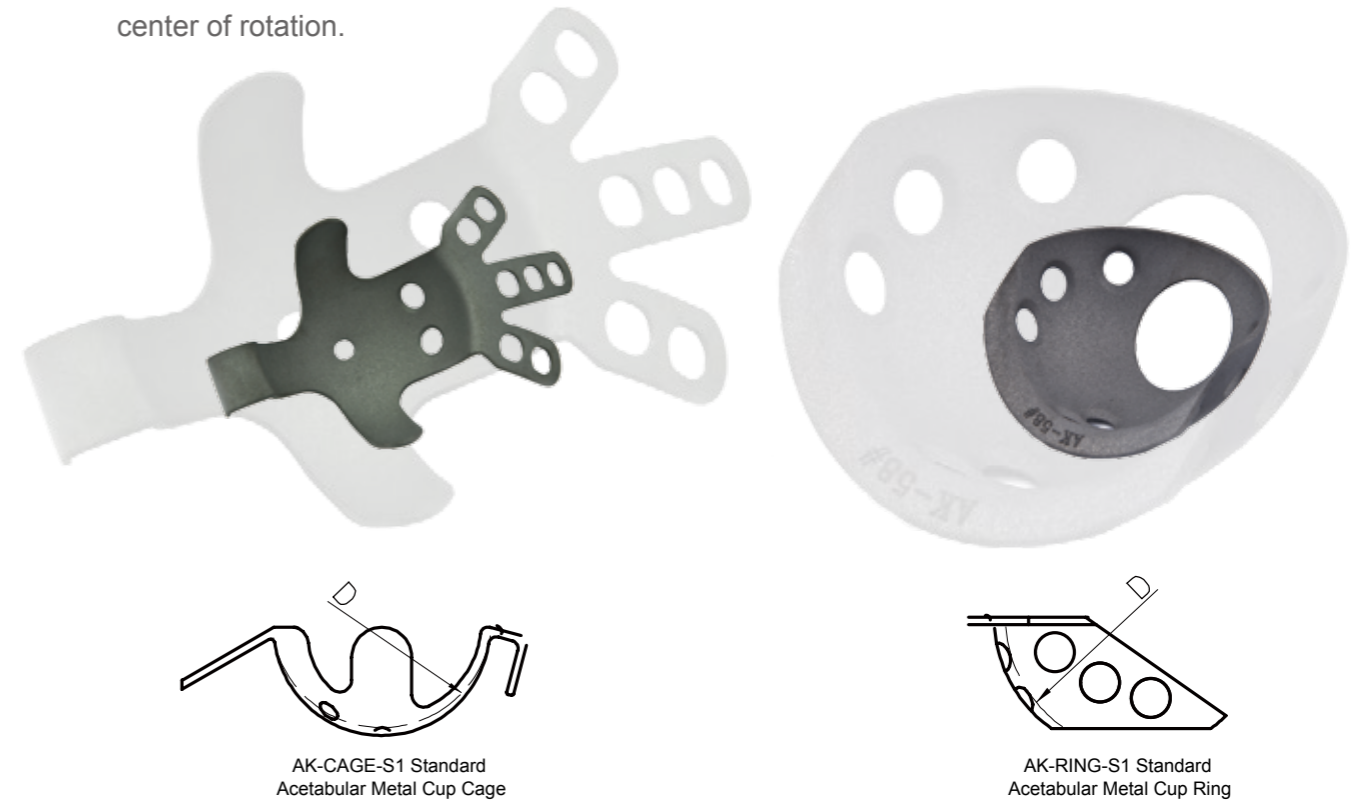

AK-CAGE-S1 Standard Acetabular Metal Cup Cage

Size Ref.	Cat. No.	Description	Dia.(D)
44#	1330-1044	Name:AK-CAGE-S1 Standard Acetabular Metal Cup Cage Material: Ti-Alloy	44
46#	1330-1046		46
48#	1330-1048		48
50#	1330-1050		50
52#	1330-1052		52
54#	1330-1054		54
56#	1330-1056		56
58#	1330-1058		58

AK-RING-S1 Standard Acetabular Metal Cup Ring

Size	Cat. No.	Description	Dia.(D)
44#	1331-1044	Name:AK-RING-S1 Standard Acetabular Metal Cup Ring Material: Ti-Alloy	44
46#	1331-1046		46
48#	1331-1048		48
50#	1331-1050		50
52#	1331-1052		52
54#	1331-1054		54
56#	1331-1060		56
58#	1331-1058		58

Accessories

Centralizer

Size Ref.	Cat. No.	Description	Inner Dia.	Outer Dia.
Universal	1100-C	Centralizer Material: UHMWPE	8	10.5



Restrictor

Size Ref.	Cat. No.	Description	Inner Dia.	Outer Dia.
Universal	1100-P	Restrictor Material: UHMWPE	3	9



AK Knee Joint Spacer Mold

Size Ref.	Cat. No.	Description	Femoral ML (mm)
S	5901-0002	AK Knee Joint Spacer Mold	60
M	5901-0003		65
L	5901-0004		70

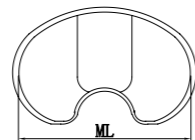
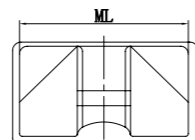

AK Hip Joint Spacer Mold

Size Ref.	Cat. No.	Head Dia. D (mm)	Stem Length L (mm)
44#	5904-0044	44	175
48#	5904-0048	48	202
52#	5904-0052	52	216

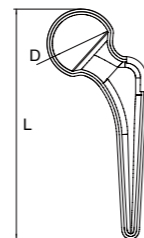

Bone Cement Applicator

Bone cement applicator is the third generation cement technic which is designed to inject cement into intramedullary. This instrument may evenly inject cement into femur during hip joint replacement surgery.

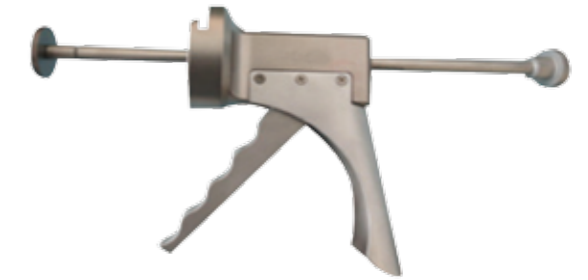

Bone Cement Application Kit



The plastic made cement sleeve assemblies are disposable for keeping bone cement. The system of devices may reduce possibilities of microbial contamination of the bone cement; also reduce the release of monomer vapors into environment; optimize mixing of the cement and make it possible for obtaining high and low viscosity cement.

Tornado Disposable Surgical Lavage Unit

Tornado Disposable Surgical Lavage Unit is a high quality, single use high pressure pulse lavage system for arthroplasty surgery. The product was developed with the specific requirements of surgeons in mind.

Tornado Disposable Surgical Lavage Unit is a ready-to-use product for joint arthroplasty and trauma surgery. The system is pre-packed with irrigation and suction nozzles which are customized for the respective usage area. The purpose is to give the surgeon different options to choose from, depending on what kind of surgery he/she will perform.





Beijing AK Medical Co., Ltd.

HK Stock Code: 01789.HK

Address: No. 10 Baifuquan Road,
Changping Science Park, Beijing
102200 China

Website: www.ak-medical.net

E-mail: sales@ak-medical.net

Tel: +86 10 8010 9581-615

Fax: +86 10 8010 9583



AK-PC-EN-2019.00